

Kozy-World®

VENT-FREE FIREPLACE

MODEL #GFD2520
GFD2545

WARNING: This appliance is equipped for (Natural and Propane) gas. Field conversion is not permitted other than between natural or propane gases.

HEATER IS PRESET FOR PROPANE AT FACTORY SEE INSTALLATION INSTRUCTIONS FOR NATURAL GAS HOOK UP.

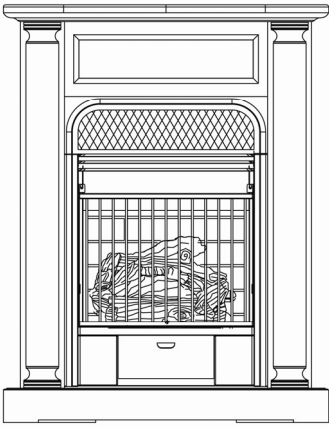

⚠ CAUTION – FOR YOUR SAFETY

⚠ WARNING: IF THE INFORMATION IN THIS MANUAL IS NOT FOLLOWED EXACTLY, A FIRE OR EXPLOSION MAY RESULT CAUSING PROPERTY DAMAGE, PERSONAL INJURY, OR LOSS OF LIFE.

- Do not store or use gasoline or other flammable vapors and liquids in vicinity of this or any other appliance.

WHAT TO DO IF YOU SMELL GAS

- Do not try to light any appliance.
- Do not touch any electrical switch; do not use any phone in your building.
- Immediately call your gas supplier from a neighbor's phone. Follow the gas supplier's instructions.
- If you cannot reach your gas supplier, call the fire department.
- Installation and service must be performed by a qualified installer, service agency or the gas supplier.

This is an unvented gas-fired heater. It uses air (oxygen) from the room in which it is installed. Provisions for adequate combustion and ventilation air must be provided. Refer to *Air for Combustion and Ventilation* section on page 7 of this manual.

INSTALLER: Leave this manual with the appliance. **CONSUMER:** Retain this manual for future reference.

This appliance may be installed in an aftermarket, permanently located, manufactured (mobile) home, where not prohibited by local codes. This appliance is only for use with propane or natural gas. This appliance is equipped with a simple means to switch between propane and natural gas. Field conversion by any other means including the use of a kit is not permitted.



Questions, problems, missing parts? Before returning to your retailer, call the KOZY WORLD PHONE NUMBER (800) 776-9425.

TABLE OF CONTENTS

Important Safety Information	3
Air for Combustion and Ventilation	7
Installation	9
Operating Heater	15
Care & Maintenance	18
Troubleshooting	19
Replacement Parts	22

⚠ WARNING: READ THE INSTALLATION & OPERATION INSTRUCTIONS BEFORE USING THIS APPLIANCE

IMPORTANT: Read instructions and warnings carefully before starting installation. Failure to follow these instructions may result in a possible fire hazard and will void the warranty.

PRODUCT SPECIFICATIONS

MODEL	GFD2520 & GFD2545	
Input Rating	20,000 BTU/Hr	19,000 BTU/Hr
Gas Type	Natural	LP/Propane
Ignition	Electronic Piezo	Electronic Piezo
Manifold Pressure	4 in. W.C.	9 in. W.C.
Inlet Gas Pressure (*For purposes of input adjustment)		
Maximum	10.5 in.	14 in.
Minimum *	5 in.	11in.
GFD2520	Dimensions, inches (H x W x D)	
Heater	37.48 in. x 29.13 in. x 13.9 in.	
Carton	40.55 in. x 32.28 in. x 17.68 in.	
GFD2545	Dimensions, inches (H x W x D) Straight	Corner
Heater	37.48 in. x 29.13 in. x 13.9 in.	37.48 in. x 29.13 in. x 27.84 in.
Carton	41.14 in. x 32.28 in. x 17.32 in.	
Weight, lbs	GFD2520	GFD2545
Stove	86.5	97
Shipping	95	107

IMPORTANT SAFETY INFORMATION

IMPORTANT: Read this owner's manual carefully and completely before trying to assemble, operate, or service this heater. Improper use of this heater can cause serious injury or death from burns, fire, explosion, electrical shock, and carbon monoxide poisoning.

Only a qualified installer, service agent, or local gas supplier may install and service this product.

WARNING: Do not store or use gasoline or other flammable vapors or liquids in the vicinity of this or any other appliance.

WARNING: This appliance can be used with propane or natural gas. It is shipped from the factory adjusted for use with propane.

CARBON MONOXIDE POISONING: Early signs of carbon monoxide poisoning resemble the flu with headaches, dizziness, or nausea. If you have these signs, the heater may not be working properly. Get fresh air immediately! Have heater serviced. Some people are more affected by carbon monoxide than others. These include pregnant women, people with heart, or lung disease, anemia, those under the influence of alcohol, and those at high altitudes.

NATURAL AND PROPANE/LP GAS: Natural and Propane/LP gases are odorless. An odor-making agent is added to the gas. The odor helps you detect a gas leak. However, the odor added to the gas can fade. Gas may be present even though no odor exists. Make certain you read and understand all warnings. Keep this manual for reference. It is your guide to safe and proper operation of this heater.

Make certain you read and understand all warnings. Keep this manual for reference. It is your guide to safe and proper operation of this heater.

 **WARNING:** Any change to this fireplace or its controls can be dangerous.

 **WARNING:** Do not allow fans to blow directly into the heater. Avoid any drafts that alter burner flame patterns including ceiling fans. Altered burner patterns can cause sooting.

Do not use a blower insert, heat exchanger insert, or other accessory not approved for use with this heater.

Due to high temperatures, the appliance should be located out of traffic and away from furniture and draperies.

Do not place clothing or other flammable material on or near the appliance. Never place any objects in the heater. Heater becomes very hot when running. Keep children and adults away from hot surfaces to avoid burns or clothing ignition. Heater will remain hot for a time after shutdown. Allow surfaces to cool before touching. Carefully supervise young children when they are in the room with heater.

You must operate this heater with the heater screen in place. Make sure heater screen is in place before running heater. Keep the appliance area clear and free from combustible materials, gasoline, and other flammable vapors and liquids.

1. Do not place Propane/LP supply tank(s) inside any structure. Propane/LP supply tank(s) must be placed outdoors.
2. This heater shall not be installed in a bedroom or bathroom.
3. Do not use this heater as a wood-burning heater. Use only the logs provided with the heater.
4. Do not add extra logs or ornaments such as pine cones, vermiculite, or rock wool. Using these added items can cause sooting. Do not add lava rock around base. Rock and debris could fall into the control area of heater. After servicing, always replace screen before operating heater.
5. Make sure the heater screen is in place before running the heater.
6. This heater is designed to be smokeless. If logs ever appear to smoke, turn off heater and call a qualified service person. **Note:** During initial operation, slight smoking could occur due to log curing and the heater burning manufacturing residues.
7. To prevent the creation of soot, follow the instructions in *Care and Maintenance* (page 18).
8. Before using furniture polish, wax, carpet cleaner, or similar products, turn heater off. If heated, the vapors from these products may create a white powder residue within burner box or on adjacent walls or furniture.
9. This heater needs fresh air ventilation to run properly. This heater has an Oxygen Depletion Sensing (ODS) safety shutoff system. The ODS shuts down the heater if not enough fresh air is available. See *Air for Combustion and Ventilation*, pages 7 through 9. If heater keeps shutting off, see *Troubleshooting*, pages 19 through 21.
10. Do not run heater:
 - Where flammable liquids or vapors are used or stored.
 - Under dusty conditions.
11. Do not use this heater to cook food or burn paper or other objects.
12. Do not use this heater if any part has been under water. Immediately call a qualified service technician to inspect the room heater and replace any part of the control system and any gas control which has been underwater.
13. Turnoff and unplug heater and let cool before servicing. Only a qualified service person should service and repair heater.
14. Operating heater above elevations of 4,500 feet could cause pilot outage.
15. Do not operate heater if any log is broken. Do not operate heater if any log is chipped (dime-sized or larger).
16. To prevent performance problems, do not use a propane/LP fuel tank of less than 100 lbs capacity.

QUALIFIED INSTALLING AGENCY

Installation and replacement of gas piping, gas utilization equipment or accessories and repair and servicing of equipment shall be performed only by a qualified agency. The term "qualified agency" means any individual, firm, corporation, or company that either in person or through a representative is engaged in and is responsible for:

- a) The installation, testing, or replacements of gas piping or
- b) The connection, installation, testing, repair, or servicing of equipment; that is experienced in such work; that is familiar with all precautions required; and that has complied with all the requirement of the authority having jurisdiction.

PRODUCT FEATURES

SAFETY PILOT

This heater has a pilot with an Oxygen Depletion Sensing (ODS) safety shutoff system. ODS/pilot is a required feature for vent-free room heaters. ODS/pilot shuts off the heater if there is not enough fresh air.

PIEZO IGNITION SYSTEM

Heater is equipped with an electronic piezo control system. This system requires AAA batteries (provided).

THERMOSTAT HEAT CONTROL

The control automatically cycles the burner on and off to maintain a desired room temperature. See page 15.

DUAL FUEL CAPABLE

Your heater is equipped to operate on either Propane or Natural gas. The heater is shipped from the factory ready for Propane connection. The heater can easily be changed to Natural gas by having your qualified installer follow the instructions on page 12 and the markings on the heater.

State of Massachusetts: The installation must be made by a licensed plumber or gas fitter in the Commonwealth of Massachusetts. Sellers of unvented propane or natural gas-fired supplemental room heaters shall provide to each purchaser a copy of 527 CMR 30 upon sale of the unit.

In the State of Massachusetts, unvented propane or natural gas-fired space heaters shall be prohibited in bedrooms and bathrooms.

In the State of Massachusetts the gas cock must be a T-handle type. The State of Massachusetts requires that a flexible appliance connector cannot exceed three feet in length.

LOCAL CODES

Install and use heater with care. Follow all local codes. In the absence of local codes, use the latest edition of the National Fuel Gas Code, ANSI Z 223.1/ NFPA 54*.

*Available from:

American National Standards Institute, Inc.
1430 Broadway
New York, NY 10018

National Fire Protection Association, Inc.
1 Batterymarch Park
Quincy, MA 02269

This heater is designed for vent-free operation. State and local codes in some areas prohibit the use of vent-free heaters.

UNPACKING

1. Remove top inner pack.
2. Tilt carton so that heater is upright.
3. Remove protective side packaging.
4. Slide heater out of carton.
5. Remove protective plastic wrap.
6. Remove screw at top of screen.
7. Hold the screen lift and pull forward.
8. Remove log set by cutting plastic.
9. Carefully unwrap log.
10. Check for any shipping damage. If heater or logs are damaged, promptly inform dealer where you bought heater.

PRODUCT IDENTIFICATION

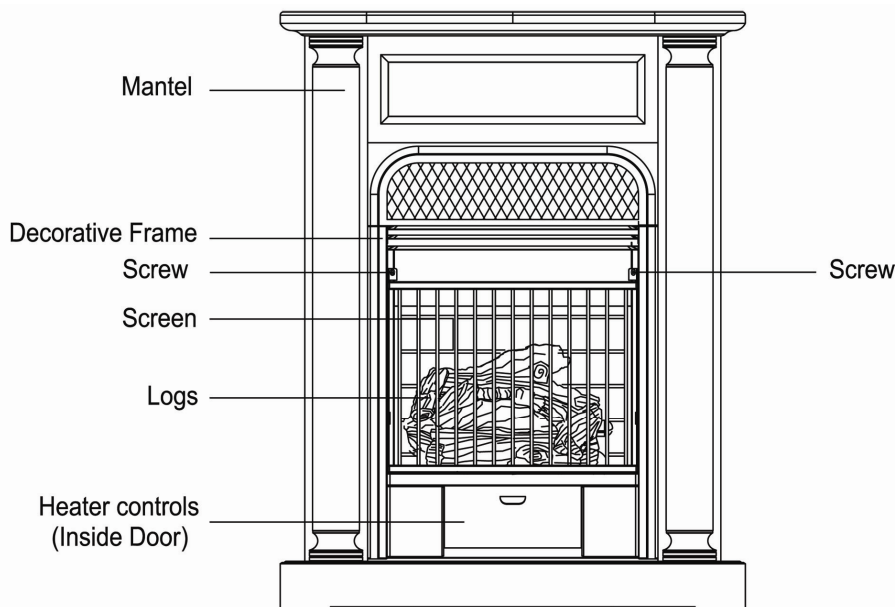

Figure 1 – Vent Free LP/NG Gas Fireplace

WATER VAPOR: A BY-PRODUCT OF UNVENTED ROOM HEATERS

Water vapor is a by-product of gas combustion. An unvented room heater produces approximately one (1) ounce (30ml) of water for every 1,000 BTU's (.3KW's) of gas input per hour.

Unvented room heaters are recommended as a supplemental heater (for a room), rather than a primary heat source (for an entire house). In most supplemental heat applications, the water vapor does not create a problem. In most applications, the water vapor enhances the low humidity atmosphere experienced during cold weather. The following steps will help insure that water vapor does not become a problem.

1. Be sure the heater is sized properly for the application, including adequate combustion air and circulation air.
2. If high humidity is experienced, a dehumidifier may be used to help lower the water vapor content of the air.
3. Do not use an unvented room heater as the primary heat source.

AIR FOR COMBUSTION AND VENTILATION

⚠ WARNING: If the area in which the heater may be operated does not meet the required volume for indoor combustion air, combustion and ventilation air shall be provided by one of the methods described in the National Fuel Gas Code, ANSI Z223.1/NFPA 54, the International Fuel Gas Code, or applicable local codes.

PRODUCING ADEQUATE VENTILATION

All spaces in homes fall into one of the three following ventilation classifications:

1. Unusually Tight Construction
2. Unconfined Space
3. Confined Space

The information on pages 7 through 9 will help you classify your space and provide adequate ventilation.

Confined and Unconfined Space

A confined space is a space whose volume is less than 50 cubic feet per 1,000 BTU per hour (4.8 cubic meter per kilowatt) of the aggregate input rating of all appliances installed in that space and an unconfined space as a space whose volume is not less than 50 cubic feet per 1,000 BTU per hour (4.8 cubic meter per kilowatt) of the aggregate input rating of all appliances installed in that space. Rooms communicating directly with the space in which the appliances are installed*, through openings not furnished with doors, are considered a part of the unconfined space.

This heater shall not be installed in a confined space or unusually tight construction unless provisions are provided for adequate combustion and ventilation air.

* Adjoining rooms are communicating only if there are doorless passageways or ventilation grills between them.

Unusually Tight Construction

The air that leaks around doors and windows may provide enough fresh air for combustion and ventilation. However, in buildings of unusually tight construction, you must provide additional fresh air.

Unusually tight construction is defined as construction where:

- a) walls and ceilings exposed to the outside atmosphere have a continuous water vapor retarder with a rating of one perm (6×10^{-11} kg per pa-sec- m^2) or less with openings gasketed or sealed and
- b) weather stripping has been added on windows that can be opened and doors and
- c) caulking or sealants are applied to areas such as joints around window and door frames, between sole plates and floors, between wall-ceiling joints, between wall panels, at penetrations for plumbing, electrical, and gas lines, and at other openings.

If your home meets all of the three criteria above, you must provide additional fresh air. See *Ventilation Air from Outdoors* (page 9). If your home does not meet all of the three criteria above, proceed to *Determining Fresh-Air Flow for Heater Location* (below).

DETERMINING FRESH-AIR FLOW FOR HEATER LOCATION

Determining if You Have a Confined or Unconfined Space

Use this worksheet to determine if you have a confined or unconfined space.

Space: Includes the room in which you will install heater plus any adjoining rooms with doorless passageways or ventilation grills between the rooms.

1. Determine the volume of the space. Length \times Width \times Height = _____ cu. ft. (volume of space)
Example: Space size 20ft. (length) \times 16ft. (width) \times 8ft. (ceiling height) = 2560cu. ft. (volume of space)
If additional ventilation to adjoining room is supplied with grills or openings, add the volume of these rooms to the total volume of the space.

2. Divide the space volume by 50 cubic feet to determine the maximum BTU/hr the space can support.

_____ (Volume of space) ÷ 50 cu. ft. = (Maximum BTU/hr the space can support)

Example: 2560 cu. ft. (volume of space) ÷ 50 cu. ft. =51.2 or 51,200(maximum BTU/hr the space can support)

Add the BTU/hr of all fuel burning appliances in the space.

Vent-free heater	_____ BTU/hr		
Gas water heater*	_____ BTU/hr		
Gas furnace	_____ BTU/hr	Example:	
Vented gas heater	_____ BTU/hr	Gas water heater	30,000 BTU/hr
Gas heater logs	_____ BTU/hr	Vent-free heater +	<u>26,000</u> BTU/hr
Other gas appliances* +	_____ BTU/hr	Total	= 56,000 BTU/hr
Total	= _____ BTU/hr		

*Do not include direct-vent gas appliances. Direct-vent draws combustion air from the outdoors and vents to the outdoors.

4. Compare the maximum BTU/hr that the space can support with the actual amount of BTU/hr used.

_____ BTU/hr (maximum the space can support)

_____ BTU/hr (actual amount of Btu/Hr used)

Example: 51,200 BTU/hr (maximum the space can support)

56,000 BTU/hr (actual amount of Btu/Hr used)

The space in the above example is a confined space because the actual BTU/hr used is more than the maximum BTU/hr the space can support. You must provide additional fresh air. Your options are as follows:

- a) Rework worksheet, adding the space of an adjoining room. If the extra space provides an unconfined space, remove door to adjoining room or add ventilation grills between rooms. See "Ventilation Air from inside building," page 8.
- b) Vent room directly to the outdoors. See "Ventilation Air from Outdoors," page 9.
- c) Install a lower BTU/hr heater, if lower BTU/hr size makes room unconfined. If the actual Btu/Hr used is less than the maximum Btu/Hr the space can support, the space is an unconfined space. You will need no additional fresh air ventilation.

WARNING: If the area in which the heater may be operated does not meet the required volume for indoor combustion air, combustion and ventilation air shall be provided by one of the methods described in the NATIONAL FUEL GAS CODE, ANSI Z223.1/NFPA 54, the INTERNATIONAL FUEL GAS CODE, or applicable local codes.

Ventilation Air from inside Building

This fresh air would come from an adjoining unconfined space. When ventilating to an adjoining unconfined space, you must provide two permanent openings: one within 12" of the ceiling and one within 12" of the floor on the wall connecting the two spaces (see options 1 and 2, Figure 2). You can also remove door into adjoining room (see option 3, Figure 2). Follow the *National Fuel Gas Code. NFPA 54/ANSI Z223.1, Air for Combustion and Ventilation* for required size of ventilation grills or ducts.

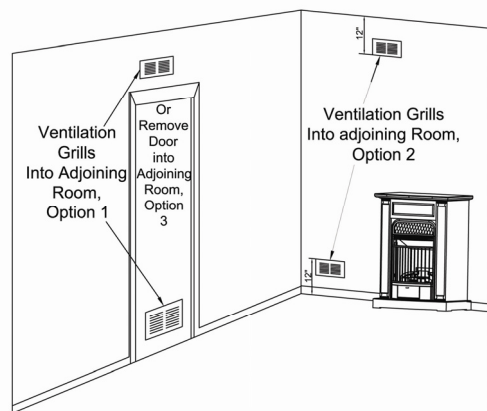

Figure 2 - Ventilation Air Inside Building

Ventilation Air from Outdoors

Provide extra fresh air by using ventilation grills or ducts. You must provide two permanent openings: one within 12" of the ceiling and one within 12" of the floor. Connect these items directly to the outdoors or spaces open to the outdoors. These spaces include attics and crawl spaces. Follow the *National Fuel Gas Code, NFPA 54/ANSI Z223.1. Air for Combustion and Ventilation* for required size of ventilation grills or ducts.

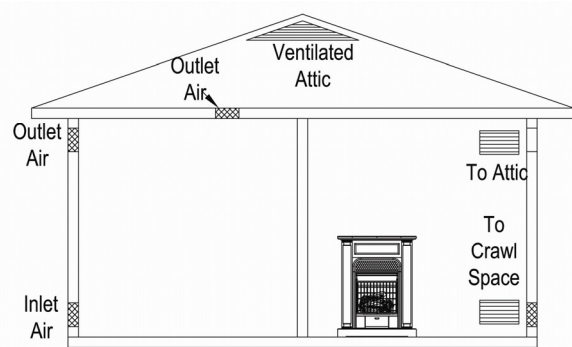

Figure 3 – Ventilation Air from Outdoors

IMPORTANT: Do not provide openings for inlet or outlet air into attic if attic has a thermostat-controlled power vent. Heated air entering the attic will activate the power vent. Rework worksheet, adding the space of the Adjoining unconfined space. The combined spaces must have enough fresh air to supply all appliances in both spaces.

INSTALLATION

NOTICE: This heater is intended for use as supplemental heat. Use this heater along with your primary heating system. Do not install this heater as your primary heat source. If you have a central heating system, you may run system's circulating blower while using the heater. This will help circulate the heat throughout the house.

WARNING: A qualified technician person must install the heater. Follow all local codes.

WARNING: Never install the heater.

- in a bedroom or bathroom
- in a recreational vehicle
- where curtains, furniture, clothing, or other flammable objects are less than 42 inches from the front, top, or sides of the heater
- in high traffic areas
- in windy or drafty areas

CAUTION: This heater creates warm air currents. These currents move heat to wall surfaces next to heater. Installing heater next to vinyl or cloth wall coverings or operating heater where impurities (such as tobacco smoke, aromatic candles, cleaning fluids, oil or kerosene lamps, etc.) in the air exist, may cause walls to discolor.

WARNING: Maintain the minimum clearances. If you can, provide greater clearances from floor, ceiling, and adjoining side and back walls.

IMPORTANT: Vent-free heaters add moisture to the air. Although this is beneficial, installing heater in rooms without enough ventilation air may cause mildew to form from too much moisture. See *Air for Combustion and Ventilation*, pages 7 through 9.

CHECK GAS TYPE

Use only the type of gas indicated on the plate. If your gas supply cannot meet that requirement, do not install heater.

CLEARANCES TO COMBUSTIBLES

Carefully follow the instructions below. This fireplace is a freestanding unit designed to set directly on the floor or on a mantel base.

IMPORTANT: You must maintain minimum wall and ceiling clearances during installation. The minimum clearances are shown in Figure 4, page 10. Measure from outermost point of fireplace.

Minimum Wall and Ceiling Clearances

(See Figure 4)

- A. Clearances from outermost point of fireplace to any combustible side wall should not be less than 12 inches.
- B. Clearances from the fireplace to the ceiling should not be less than 48 inches.

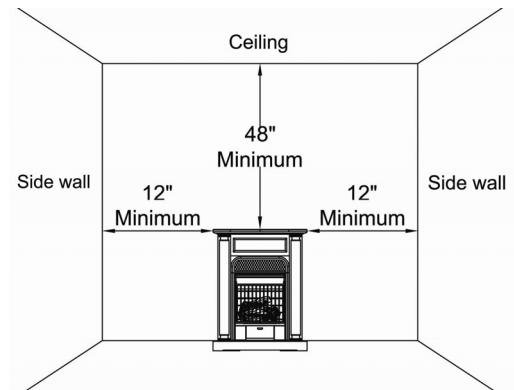

Figure 4 – Minimum Clearance to Wall and Ceiling

CONNECTING TO GAS SUPPLY

WARNING: A qualified technician must connect heater to gas supply. Follow all local codes.

CAUTION: Never connect heater directly to the gas supply. This heater requires an external regulator (not supplied). The external regulator between the gas supply and heater must be installed.

INSTALLATION ITEMS NEEDED

Before installing heater, make sure you have the items listed below.

- piping (check local codes)
- sealant (resistant to propane/LP gas)
- equipment shutoff valve*
- test gauge connection**
- sediment trap
- tee joint
- pipe wrench
- Flexible Gas hose (check local code)

* A CSA design-certified equipment shutoff valve with 1/8" NPT tap is an acceptable alternative to test gauge connection. Purchase the optional CSA design-certified equipment shutoff valve from your dealer.

WARNING: Never connect heater to private (non-utility) gas wells. This gas is commonly known as wellhead gas.

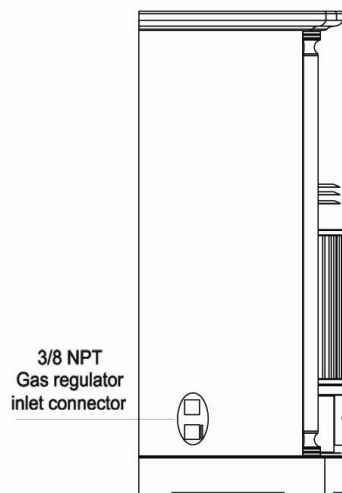

Figure 5 -Gas Regulator Location and Gas Line Access into Fireplace Cabinet

INSTALLATION CONTINUED

The installer must supply an external regulator. The external regulator will reduce incoming gas pressure. You must reduce incoming gas pressure to between 11 and 14 inches of water column for propane and between 5 and 10.5 inches of water column for natural gas. If you do not reduce incoming pressure, heater regulator damage could occur.

Install external regulator with the vent pointing down as shown in Figure 6. Pointing the vent down protects it from freezing rain or sleet.

CAUTION: Use only new black iron or steel pipe. Internally-tinned copper tubing may be used in certain areas. Check your local codes. Use pipe of 1/2" diameter or greater to allow proper gas volume to heater. If pipe is too small, a loss of pressure will occur. Installation must include an equipment shutoff valve, union, and plugged 1/8" NPT tap. Locate NPT tap within reach for test gauge hook up. NPT tap must be upstream from heater (see Figure 7).

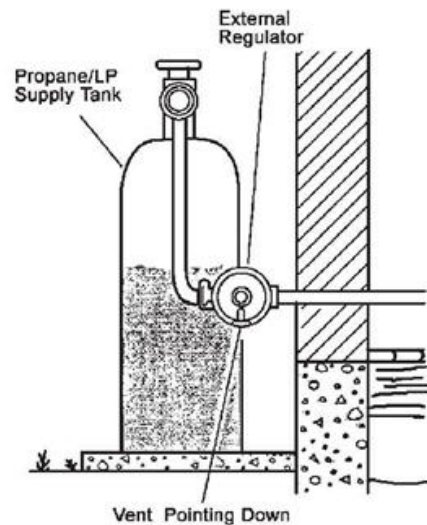

Figure 6 – External Regulator with Vent Pointing Down

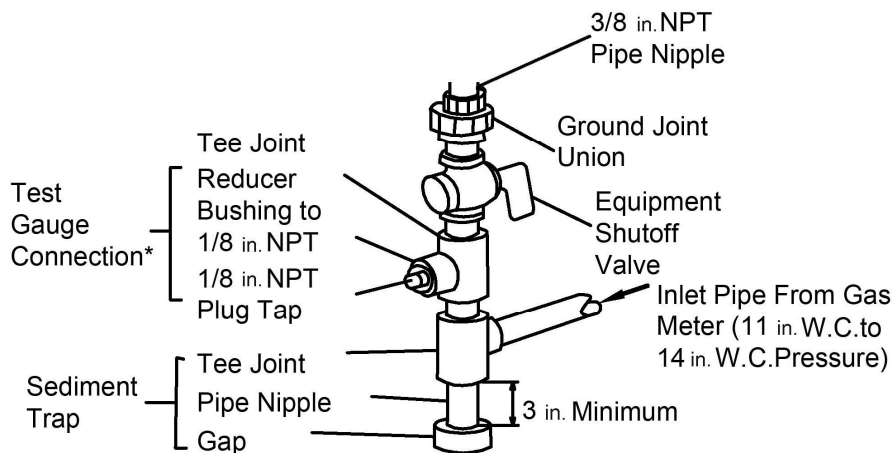

Figure 7 – Gas Connection

* Purchase the optional CSA design-certified equipment shut off valve from your dealer. See *Accessories*.

** Minimum inlet pressure for purpose of input adjustment.

IMPORTANT: Install equipment shutoff valve in an accessible location. The equipment shutoff valve is for turning on or shutting off the gas to the appliance. Apply pipe joint sealant lightly to male threads. This will prevent excess sealant from going into pipe. Excess sealant in pipe could result in clogged heater valves.

CAUTION: Use pipe joint sealant that is resistant to gas (PROPANE or NG). We recommend that you install a sediment trap in a supply line as shown in Figure 7. Locate sediment trap where it is within reach for cleaning. Install in the piping system between fuel supply and heater. Locate sediment trap where trapped matter is not likely to freeze. A sediment trap traps moisture and contaminants. This keeps them from going into heater controls. If sediment trap is not installed or is installed incorrectly, heater may not run properly.

CAUTION: Avoid damage to regulator. Hold gas regulator with wrench when connecting into gas piping and/or fittings.

INSTALLATION CONTINUED

CAUTION: Two gas line installations at the same time are prohibited. The access plate to the simple switching means shall not be opened while the heater is in operation.

This appliance can be used with propane or natural gas. It is shipped from the factory adjusted for use with propane. Only a qualified installer or service technician can perform gas selection and connecting to gas supply.

⚠ CAUTION: To avoid gas leakage at the inlet of regulator, a qualified installer or service technician must use steel or metal hex plug with sealant.

For changing from propane to natural gas supply

1. Remove bottom screw from cover plate, see figure 8, and rotate to expose fuel selection device.
2. For NATURAL GAS, press in knob using a flat screwdriver with a blade the thickness of a quarter and turn knob clockwise until the  knob locks into the NG position (see figure 9). Fuel selection device must be locked into the NG position. Do not operate heater between locked positions!
3. Rotate and close cover over fuel selection device and reinstall screw.
4. Remove hex plug (with wrench provided from natural gas inlet of regulator and install into LP inlet of regulator, use thread sealant to assure there are no leaks).

For changing from natural gas supply to propane gas supply:

1. Remove bottom screw from cover plate, see figure 8, and rotate to expose fuel selection device.
2. For propane gas, press in knob using a flat screwdriver with a blade the thickness of a quarter and turn knob counterclockwise  until the knob locks into the LP position (see figure 10). Fuel selection device must be locked into the LP position.
3. Rotate and close cover over fuel selection device and reinstall screw.
4. Remove hex plug from propane gas inlet of regulator and install into NG inlet of regulator, use thread sealant to assure there are no leaks.

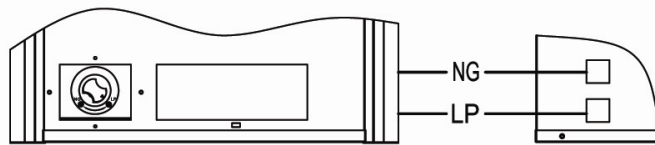

Figure 8

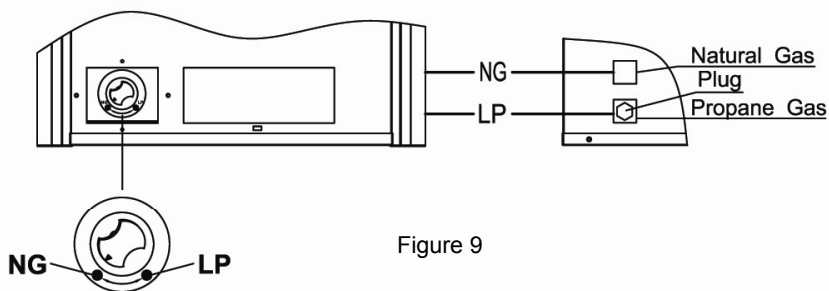

Figure 9

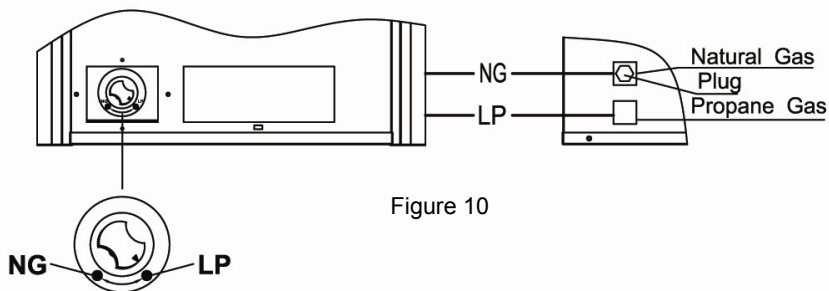

Figure 10

CHECKING GAS CONNECTIONS

WARNING: Test all gas piping and connections for leaks after installing or servicing. Correct all leaks immediately.

Pressure Testing Gas Supply Piping System

Test Pressures In Excess Of 1/2 PSIG (3.5kPa)

1. Disconnect heater with its appliance main gas valve (control valve) and equipment shutoff valve from gas supply piping system. Pressures in excess of 1/2 psig will damage heater regulator.
2. Cap off open end of gas pipe where equipment shutoff valve was connected.
3. Pressurize supply piping system by either using compressed air or opening gas supply tank valve.
4. Check all joints of gas supply piping system. Apply mixture of liquid soap and water to gas joints. Bubbles forming show a leak.
5. Correct all leaks immediately.
6. Reconnect heater and equipment shutoff valve to gas supply. Check reconnected fittings for leaks.

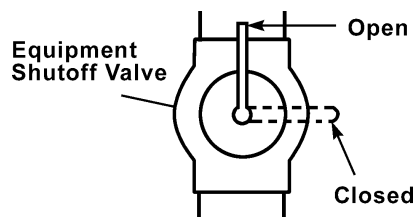

Figure 11-Equipment Shutoff Valve

WARNING: Never use an open flame to check for a leak. Apply a mixture of liquid soap and water to all joints. Bubbles forming show a leak. Correct all leaks immediately.

Pressure Testing Heater Gas Connections

1. Open equipment shutoff valve (see Figure 11).
2. Open gas supply tank valve.
3. Make sure control knob of heater is in the OFF position.
4. Check all joints from equipment shutoff valve to control valve (Figure 11). Apply mixture of liquid soap and water to gas joints. Bubbles forming show a leak.
5. Correct all leaks immediately.
6. Light heater (see *Operating Heater*, page 15). Check all other internal joints for leaks.
7. Turn off heater (see *Operation of Turn-Off*, page 16).

CAUTION: Make sure external regulator has been installed between gas supply and heater. See guidelines under *Connecting to Gas Supply* (page 10).

Test Pressures Equal To or Less Than 1/2 PSIG (3.5 kPa)

1. Close equipment shutoff valve (see Figure 11).
2. Pressurize supply piping system by either using compressed air or opening gas supply tank valve.
3. Check all joints from gas meter to equipment shutoff valve (see Figure 12). Apply mixture of liquid soap and water to gas joints. Bubbles forming show a leak.
4. Correct all leaks immediately.

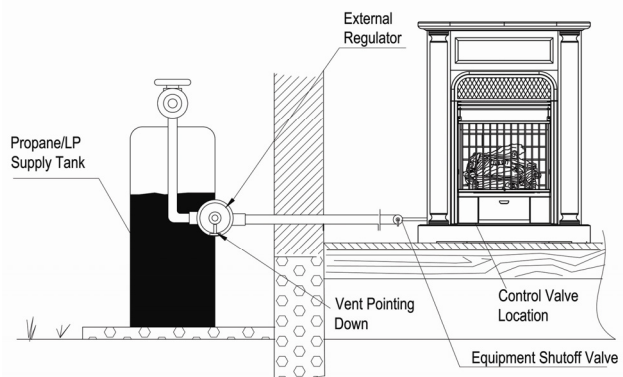
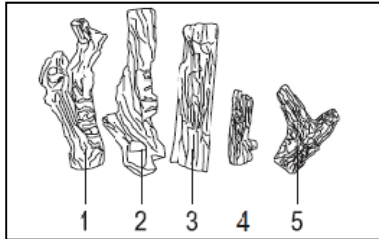

Figure 12 Checking Gas Joins

INSTALLING LOGS

⚠ WARNING: Failure to position the parts in accordance with these diagrams or failure to use only parts specifically approved with this heater may result in property damage or personal injury.

⚠ CAUTION: After installation and periodically thereafter, check to ensure that no flame comes in contact with any log. With the heater set to high, check to see if flames contact any log. If so, reposition logs according to the log installation instructions in this manual. Flames contacting logs will create soot.



All logs

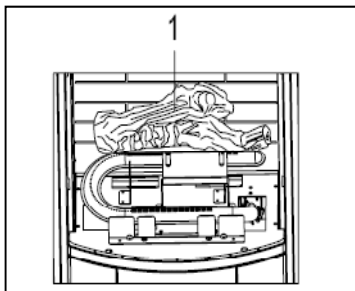

STEP 1: Install log 1 onto the two slots in the rear firebox panel.

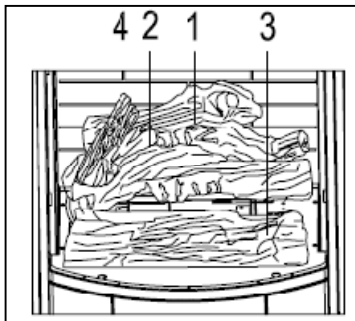

STEP 4: Insert the recessed hole on the bottom of log 4 onto the pin on log 1, with the other end of log 4 placed on log 2, as shown.

Figure 13-Installing Log Set

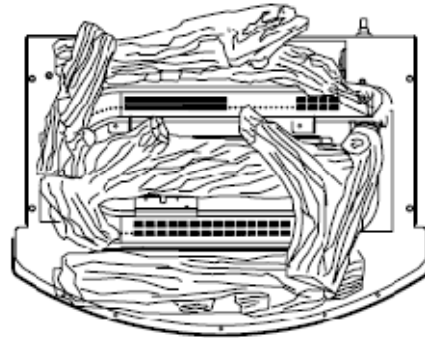

IMPORTANT: Make sure log does not cover any burner ports (see Figure 13). It is very important to install the logs exactly as instructed. Do not modify logs. Only use logs supplied wall heater.

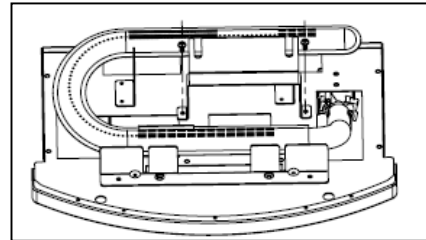

Installing Mid Log Bracket

Attach mid log bracket in burner pan with two knob screws.

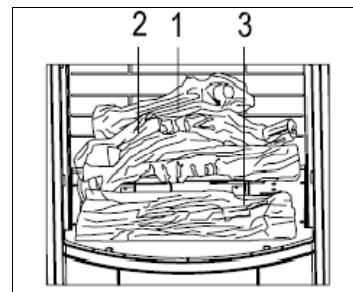

STEP 2: Install log 2 onto the two slots in middle plate.
STEP 3: Install log 3 onto the two slots in front plate.

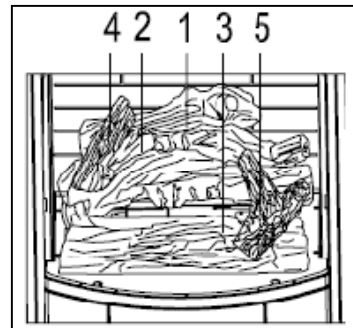

STEP 5: Insert the recessed hole on the bottom of log 5 onto the pin on log 2, with the other end of log 5 placed on log 3, as shown.

OPERATING HEATER

FOR YOUR SAFETY READ BEFORE LIGHTING

⚠ WARNING: If you do not follow these instructions exactly, a fire or explosion may result causing property damage, personal injury or loss of life.

⚠ NOTICE: During initial operation of the new fireplace, burning logs will give off a paper-burning smell. Orange flame will also be present. Open a window to vent smell. This will only last a few hours.

⚠ CAUTION: Do not try to adjust heating levels by using the equipment shutoff valve.

- A. This appliance has a pilot which must be lighted by the electronic ignitor. When lighting the pilot, follow these instructions exactly.
- B. BEFORE LIGHTING smell all around the appliance area for gas. Be sure to smell next to the floor because some gas is heavier than air and will settle on the floor.

WHAT TO DO IF YOU SMELL GAS

- Do not try to light any appliance.
 - Do not touch any electrical switch; do not use any phone in your building.
 - Immediately call your gas supplier from a neighbor's phone. Follow the gas supplier's instructions.
 - If you cannot reach your gas supplier, call the fire department
- C. Use only your hand to push in control knob. Never use tools. If the appliance could not operate, do not try to repair it, Call a qualified service technician or gas supplier. Forced or attempted, re-pair may result in a fire or explosion.
 - D. Do not use this appliance if any part has been under water. Immediately call a qualified service technician to inspect the appliance and to replace any part of the control system and any gas control which has been under water.

Note: Please wait one minute after shutting off fireplace to allow the electronic module to reset before starting again.

THERMOSTATIC CONTROL OPERATION

Note: The thermostatic control valve used on this model differs from standard thermostats. Standard thermostats simply turn the burner on and off. The thermostat sensing bulb on the control valve used on this heater senses changes in room temperature and will vary the flame accordingly. When the room temperature exceeds the set temperature the burner will shut off completely. The unit will cycle back on as the room temperature drops below the set temperature. The control knob can be set to the desired comfort level between HIGH (5) and LOW (1).

LIGHTING INSTRUCTIONS

1. **STOP!** Read the safety information on page 3.
2. Unscrew ignitor cap and install a AAA type battery with its anode (“+”) pointing out. Replace cap
3. Make sure equipment shutoff valve is fully open.
4. **Warning:** You must operate this fireplace with the fireplace screen in place. Make sure fireplace screen is installed before running fireplace.
5. Turn control knob clockwise to the OFF position, see Figure 14.
6. Wait five (5) minutes to clear out any gas. Then smell for gas around heater and near floor. If you smell gas, STOP! Follow "B" in the safety information on Warnings plate. If you don't smell gas, go to the next step.
7. Turn control knob counterclockwise to the PILOT position. Keep control knob pressed in for five (5) seconds. **Note:** You may be running this heater for the first time after hooking up to gas supply. If so, the control knob may need to be pressed in for 30 seconds. This will allow air to bleed from the gas system. If control knob does not pop up when released, contact a qualified service person or gas supplier for repairs.
8. With control knob pressed in, push and hold ignitor button. This will light pilot. The pilot is attached to the rear of the front burner. If needed, keep pressing ignitor button until pilot lights. **Note:** If pilot does not stay lit, contact a qualified service person or gas supplier for repairs. Until repairs are made, light pilot with match.
9. Keep control knob pressed in for 30 seconds after lighting pilot. After 30 seconds, release control knob. **Note:** If pilot goes out, repeat steps 3 through 8. This heater has a safety interlock system. Wait one (1) minute before lighting pilot again.
10. **Warning:** Make sure while the input gas type is NG, pilot burner NG ignites; while the input type is LP, pilot burner LP ignites. **Note:** If you find anything abnormal in this step, repeat steps 2 through 8.
11. Turn control knob counterclockwise to the desired heating level. The main burner should light. Set control knob to any heat level between HI and LO (5 – 1).

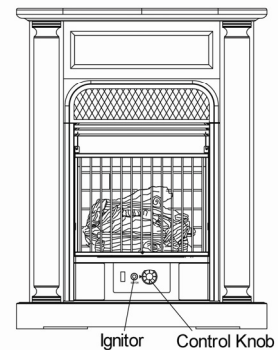



Figure 14

TO TURN OFF GAS TO APPLIANCE

Shut off heater

Turn Control Knob clockwise  to the OFF position. Do not force.

BATTERY INSTRUCTIONS

- Battery is included.
- Remove battery when depleted.
- Install/replace the battery according to the type and quantity stated in table below.
- Do not mix old and new batteries. New battery should be the same brand for best results.
- Be sure to observe proper polarity (+/-) when installing or replacing the batteries. Damage due to improper battery installation may void the warranty on the product.

Component	Type of Battery	Battery Qty.
Ignitor	AAA	1

MANUAL LIGHTING PROCEDURE

(Match Light)

1. Remove screen by lifting and pulling forward.
2. Follow steps 1 through 7 under MANUAL OPERATING Lighting Instructions.
3. With Control Knob in PILOT position, strike match, and hold near pilot. Press in Control Knob; pilot should light.
4. Keep Control Knob pressed in for 30 seconds after lighting pilot. After 30 seconds, release Control Knob.
5. Make sure the fireplace screen is in place before operating fireplace.

INSPECTING BURNERS

1. Turn control knob to pilot position
 2. Inspect pilot flame and refer to Figure 15 and 16.
- Figure 15 shows a correct pilot flame pattern.
 - Figure 16 shows an incorrect pilot flame pattern. The incorrect pilot flame is not touching the thermocouple. This will cause the thermocouple to cool. When the thermocouple cools, the heater will shut down.
 - If the pilot flame is incorrect, as shown in Figure 16. Turn heater off (see To Turn off Gas to Appliance, page 16) See troubleshooting, page 19~21.

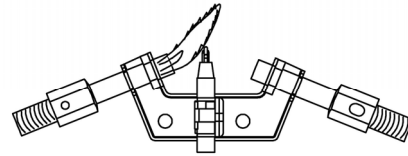

Figure 15 - Correct Pilot Flame Pattern

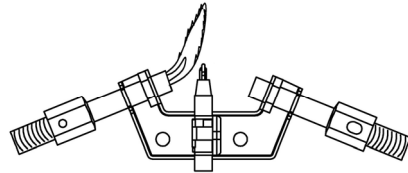

Figure 16 - Incorrect Pilot Flame Pattern

BURNER FLAME PATTERN

- Figure 17 shows a correct burner flame pattern.
- Figure 18 shows an incorrect burner flame pattern. If burner flame is incorrect:
Turn heater off (see To Turn off Gas to Appliance, page 16) see Troubleshooting, Page 19~21.

Approx. 3-6" Above
Top of logs

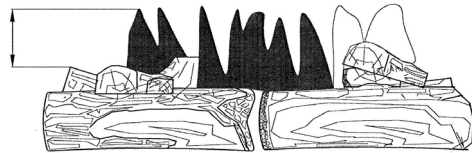

Figure 17 - Correct Flame Pattern with Control Knob Set to High Flame

More Than 8"
Above Top of logs

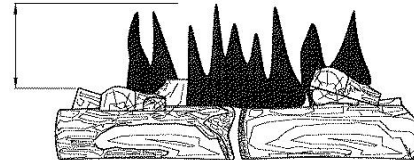

Figure 18 - Incorrect Flame Pattern with Control Knob Set to High (5)

Blower (OPTIONAL ACCESSORY)

Refer to model 20-6030 manual.

CARE AND MAINTENANCE

WARNING: Disconnect power before attempting any maintenance or cleaning to reduce the risk of fire, electric shock or personal injury. Turn off heater and let cool before cleaning.

WARNING: Failure to keep primary air openings of burners clean may result in sooting and property damage.

CAUTION: You must keep control areas, burner, and circulating air passageways of heater clean. Inspect these areas of heater before each use. Have heater inspected yearly by a qualified service person. Heater may need more frequent cleaning due to excessive lint from carpeting, bedding material, pet hair, etc.

CLEANING ODS/IGNITOR AND BURNER

Clean with a vacuum cleaner.

CLEANING BURNER INJECTOR HOLDER AND PILOT AIR INLET HOLE

We recommend that you clean the unit every three months or after 500 hours of operation. We also recommend that you keep the burner tube and pilot assembly clean and free of dust and dirt. To clean these parts we recommend using compressed air no greater than 30 PSI. You can use a vacuum cleaner in the blow position. If using compressed air in a can, please follow the directions on the can. If you don't follow directions on the can, you could damage the pilot assembly.

1. Shut off the unit, including the pilot. Allow the unit to cool for at least thirty minutes.
2. Inspect burner, pilot and primary air inlet holes on injector holder for dust and dirt (see figure 19).
3. Blow air through the ports/slots and holes in the burner.
4. Check the injector holder located at the end of the burner tube again. Remove any large particles of dust, dirt, lint, or pet hair with a soft cloth or vacuum cleaner nozzle.
5. Blow air into the primary air holes on the injector holder (see Figure 19).
6. In case any large clumps of dust have now been pushed into the burner, repeat steps 3 and 4.

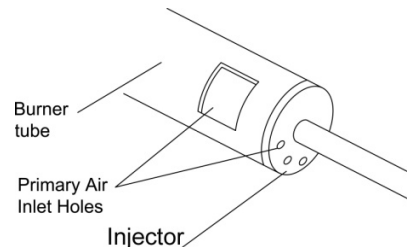

Figure 19 Inject or holder on

Clean the pilot assembly also. A yellow tip on the pilot flame indicates dust and dirt in the pilot assembly. There is a small pilot air inlet hole about two inches from where the pilot flame comes out of the pilot assembly (see figure 20). With the unit off, lightly blow air through the air inlet hole. You may blow through a drinking straw if compressed air is not available.

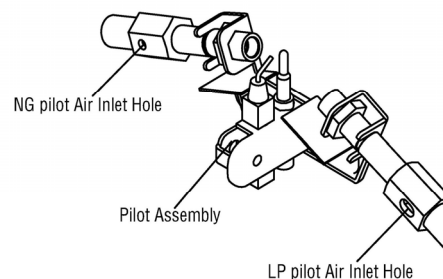

Figure 20 – Injector holder on

CABINET

Air Passageways

- Use a vacuum cleaner or pressurized air to clean.

Exterior

- Use a soft cloth dampened with a mild soap and water mixture. Wipe the cabinet to remove dust.

LOGS

- If you remove logs for cleaning, refer to *Installing Logs* (page 14) to properly replace logs.
- Replace logs if broken or chipped (dime-sized or larger).

MAIN BURNER

Periodically inspect all burner flame holes with the heater running. All slotted burner flame holes should be open with yellow flame present. All round burner flame holes should be open with a small blue flame present. Some burner flame holes may become blocked by debris or rust, with no flame present. If so, turn off heater and let cool. Either remove blockage or replace burner. Blocked burner flame holes will create soot.

TROUBLESHOOTING

NOTE: Turn the control knob to “OFF” position first and wait for one minute. Then turn the control knob to the “ON” position. Please wait for one minute to allow valve to reset.

WARNING: If you smell gas

- Shut off gas supply.
- Do not try to light any appliance.
- Do not touch any electrical switch; do not use any phone in your building.
- Immediately call your gas supplier from a neighbor’s phone. Follow the gas supplier’s instructions.
- If you cannot reach your gas supplier, call the fire department.

WARNING: Make sure that power is turned off before proceeding.

WARNING: Turn off and let cool before servicing. Only a qualified service person should service and repair fireplace.

CAUTION: Never use a wire, needle, or similar object to clean ODS/pilot. This can damage ODS/pilot unit.

OBSERVED PROBLEM	POSSIBLE CAUSE	REMEDY
When ignitor button is pressed in, there is no spark at ODS/pilot	<ol style="list-style-type: none"> 1. Ignitor is positioned wrong. 2. Ignitor electrode is broken. 3. Ignitor electrode is not connected to ignitor cable. 4. Ignitor cable is pinched. 5. Damaged ignitor cable. 6. Bad piezo ignitor. 7. Low battery. 	<ol style="list-style-type: none"> 1. Replace ignitor. 2. Replace electrode. 3. Reconnect ignitor cable. 4. Free ignitor cable if pinched by any metal or tubing. 5. Replace ignitor cable. 6. Replace piezo ignitor. 7. Replace battery.
When ignitor button is pressed in, there is a spark at ODS/pilot but no pilot flame present.	<ol style="list-style-type: none"> 1. Gas supply is turned off or equipment shutoff valve is closed. 2. Control knob not fully pressed in while pressing ignitor button. 3. Air in gas lines (new installation or recent gas interruption). 4. ODS/pilot is clogged. 5. Incorrect inlet gas pressure or inlet regulator is damaged. 6. Depleted gas supply 	<ol style="list-style-type: none"> 1. Turn on gas supply or open equipment shutoff valve. 2. Fully press in control knob while pressing ignitor button. 3. Continue holding down control knob for 30 seconds to remove air. Repeat igniting operation until air is removed. 4. Clean ODS/pilot (see <i>Care and Maintenance</i> Page 18) or replace ODS/pilot assembly. 5. Check inlet gas pressure or replace inlet gas regulator. 6. Contact local propane/LP Gas Company

OBSERVED PROBLEM	POSSIBLE CAUSE	REMEDY
ODS/pilot lights but flame goes out when control knob is released.	<ol style="list-style-type: none"> 1. Control knob is not fully pressed in. 2. Control knob is not pressed in long enough. 3. Equipment shutoff valve is not fully open. 4. Thermocouple connection is loose. 5. Thermocouple damaged 6. Control valve damaged. 	<ol style="list-style-type: none"> 1. Press in control knob fully. 2. After ODS/pilot lights, keep control knob pressed in 30 seconds. 3. Fully open equipment shutoff valve. 4. Hand tighten until snug, and then tighten ¼ turn more. 5. Replace thermocouple. 6. Contact customer service.
Burner(s) does not light after ODS/pilot is lit.	<ol style="list-style-type: none"> 1. Burner orifice is clogged. 2. Burner orifice diameter is too small. 3. Inlet gas pressure is too low. 	<ol style="list-style-type: none"> 1. Clean burner (see <i>Care and maintenance</i> Page 18) or contact customer service. 2. Contact customer service. 3. Contact your gas supplier.
Delayed ignition of burner(s).	<ol style="list-style-type: none"> 1. Manifold pressure is too low. 2. Burner orifice is clogged. 	<ol style="list-style-type: none"> 1. Contact your gas supplier. 2. Clean burner orifice (see <i>Care and maintenance</i> Page 18) or replace burner orifice.
Burner backfiring during combustion.	<ol style="list-style-type: none"> 1. Burner orifice is clogged or damaged. 2. Burner is damaged. 3. Gas regulator is damaged. 	<ol style="list-style-type: none"> 1. Clean burner orifice (see <i>Care and maintenance</i> Page 18) or Contact customer service. 2. Contact Dealer or Customer Service. 3. Replace gas regulator.
High yellow flame during burner combustion.	<ol style="list-style-type: none"> 1. Gas selection valve not set correctly. 2. Dirty or clogged burner. 3. Not enough air. 4. Gas regulator is defective. 5. Inlet gas pressure is too low. 	<ol style="list-style-type: none"> 1. Make sure gas selection valve is set properly. 2. Check burner for dirt and debris. If found, clean burner orifice (see <i>Care and Maintenance</i> Page18). 3. Replace gas regulator. 4. Contact your gas supplier. 5. Check inlet pressure.
Slight smoke or odor during initial operation	<ol style="list-style-type: none"> 1. Residues from manufacturing process. 	<ol style="list-style-type: none"> 1. Problem will stop after a few hours of operation.
Heater produces a whistling noise when burner is lit.	<ol style="list-style-type: none"> 1. Turning control knob to HIGH (5) position when burner is cold. 2. Air in gas line. 3. Air passageways on heater are blocked. 4. Dirty or partially clogged burner orifice. 	<ol style="list-style-type: none"> 1. Turn control knob to LOW (1) position and let warm up for a minute. 2. Operate burner until air is removed from line. Have gas line checked by local propane/LP Gas Company. 3. Observe minimum installation clearances (Figure 4, page 10). 4. Clean burner orifice (see <i>Care and Maintenance</i> Page 18) or replace burner orifice.
Heater produces a clicking/ticking noise just after burner is lit or shut off.	<ol style="list-style-type: none"> 1. Metal is expanding while heating or contracting while cooling. 	<ol style="list-style-type: none"> 1. This is common with most heaters. If noise is excessive, contact qualified service technician.

OBSERVED PROBLEM	POSSIBLE CAUSE	REMEDY
White powder residue forming within burner box or on adjacent walls or furniture	1. When heated, the vapors from furniture polish, wax, carpet cleaners, etc., turn into white powder residue.	1. Turn heater off when using furniture polish, wax, and carpet cleaner or similar products.
Gas odor during combustion.	1. Foreign matter between control valve and burner. 2. Gas leak. (See Warning Statement at top of page 19).	1. Contact Dealer or Customer Service. 2. Locate and correct all leaks (see "Checking Gas Connections", page 13).
Heater shuts off in use (ODS operates).	1. Not enough fresh air is available. 2. Low line pressure. 3. ODS/pilot is partially clogged.	1. Open window and/or door for ventilation. 2. Contact local gas supplier. 3. Clean ODS/pilot (see <i>Care and Maintenance</i> , page 18).
Gas odor exists even when control knob is in OFF position.	1. Gas leak. See Warning Statement at top of page 19. 2. Control valve is defective.	1. Locate and correct all leaks (see "Checking Gas Connections", page 13). 2. Contact customer service.

REPLACEMENT PARTS

NOTE: Use only original replacement parts. This will protect your warranty coverage for parts replaced under warranty.

PARTS UNDER WARRANTY

Contact authorized dealers of this product. If they can't supply original replacement parts, call Customer Service toll free at **(800) 776-9425** for referral information.

When calling Customer Service or your dealer, have ready:

- Your name
- Your address
- Model and serial number of your heater
- How heater was malfunctioning
- Type of gas used (Propane/LP or Natural gas/NG)
- Purchase date
- Usually, we will ask you to return the defective part to the factory

PARTS NOT UNDER WARRANTY

Contact authorized dealers of this product. If they can't supply original replacement part(s) call Customer Service toll free at **(800) 776-9425** for referral information.

When calling Customer Service have ready:

- Model number of your heater
- The replacement part number

World Marketing of America, Inc.
P.O. Box 192, Rt. 22 West
MillCreek, PA 17060

KOZY-WORLD PHONE NUMBER :(800) 776-9425

<http://www.worldmkting.com>

PARTS LIST

This list contains replaceable parts used in your heater. When ordering parts, follow the instructions listed under Replacement Parts on page 22 of this manual.

Key No.	Part Number	Description	QTY
1	PSD20T230	Burner Assembly	1
2	NDD0308-400	DF ODS	1
3	SIT545-200	T-Stat Valve Assembly	1
4	PIMSC1-01	Piezo Ignitor	1
5	RV83FI-4/9	DF Regulator	1
6	YDF06-ED200T	Fuel Selection Device Assembly	1
7	ED200T2310	Main Outlet Tube Assembly	1
8	ED200T2320	Main Inlet Tube Assembly	1
9	ED200T2330	ODS/Pilot Gas Tube Assembly	1
10	ED200T2340	ODS Outlet Tube Assembly(LP)	1
11	ED200R2350	ODS Outlet Tube Assembly(NG)	1

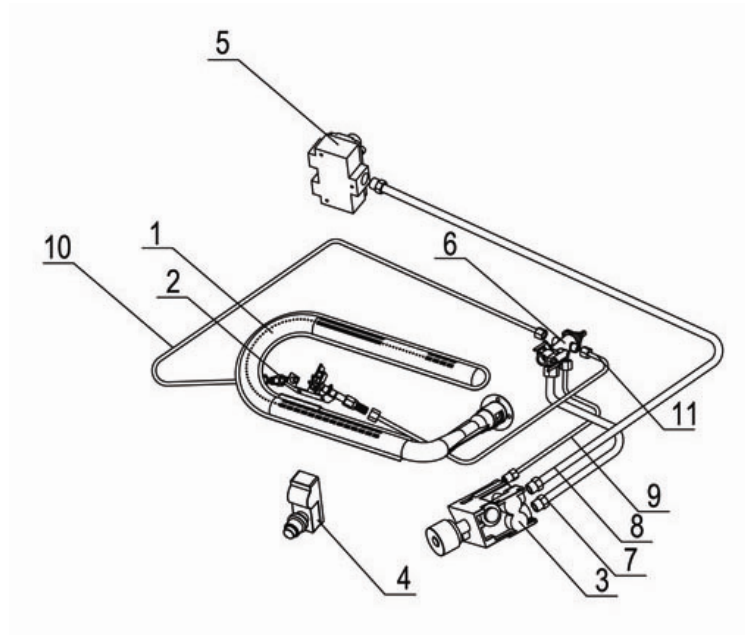

PARTS LIST

This list contains replaceable parts used in your heater. When ordering parts, follow the instructions listed under *Reparts* on page 22 of this manual.

Key NO.	Part Number	Description	QTY	
			GFD2520	GFD2545
1	ED200L14B-400-O	Mantel Assembly	1	
2	ED200L7C-400-MO	Mantel Assembly		1
3	ED200T2002	Top Panel	1	1
4	ED200T2001	Body Boarding	1	1
5	ED200T2003	Bottom Panel	1	1
6	ED200T2040	Firebox Assembly	1	1
7	EL010-01C-02B	Inner Decorative Frame Assembly	1	1
8	EL002-01A-01	Upper Louver	1	1
9	EL003-01A-01	Mid Louver	1	1
10	PSD20T201	Burner Pan	1	1
11	AN/LI200MV-202	Mid Log Bracket	1	1
12	EL012-06B-01	Lower Front Panel (Right)	1	1
13	EL012-06A-01	Lower Front Panel (Left)	1	1
14	ED200T005B	Control Panel Assembly	1	1
15	EB29600H	Grill Assembly	1	1
16	EL013-01B1-01	Door	1	1
17	EL010-01B-01	Right Decorative Trim	1	1
18	EL010-01A-01	Left Decorative Trim	1	1
19	ED200T500	Log Assembly	1	1
20	ED200T501	Log 1	1	1
21	ED200T502	Log 2	1	1
22	ED200T503	Log 3	1	1
23	ED200T504	Log 4	1	1
24	ED200T505	Log 5	1	1
PART AVAILABLE----NOT SHOWN				
	ED200T2401	Hardware Package	1	1

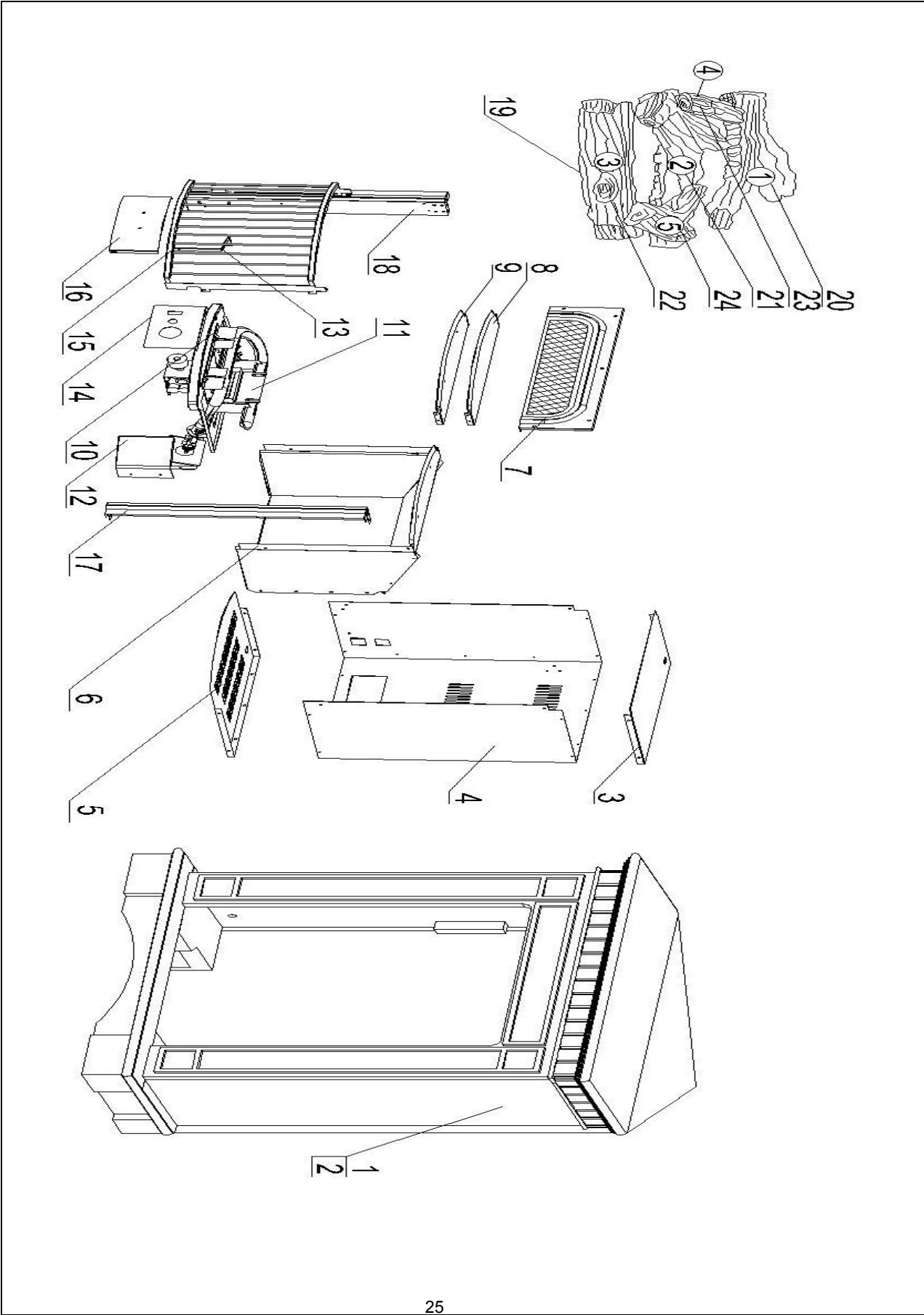

CORNER MANTEL TRIM (FOR GFD2545)



CAUTION: If baseboards are installed where the fireplace is intended to be displayed, then the fireplace will not fit flush against the wall.

For a proper flush fit, you may need to remove part of the baseboard molding if necessary.

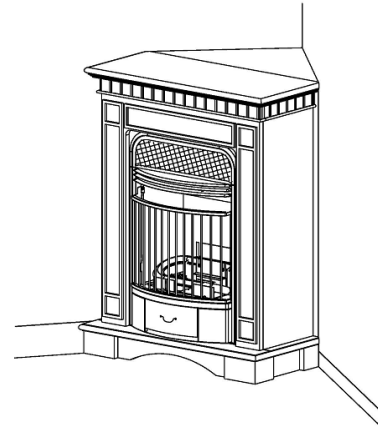

HARDWARE CONTENTS

Part	Description	Quantity	(Shown to size)
AA	ST 5 Screw – 2 3/8 in.	2	
BB	ST4 Screw - 1 3/16 in.	8	
CC	ST4 Screw - 5/8 in.	12	
DD	Wall Anchor	2	

PREPARATION

Before beginning assembly of product, make sure all parts are present. Compare parts with replacement parts list on page 24 and 25. If any part is missing or damaged, do not attempt to assemble the product. Contact customer service for replacement parts.

Estimated Assembly Time: 60 minutes

Tools Required for Assembly: Phillips Screwdriver, Flathead Screwdriver, Drill, and Tape Measure

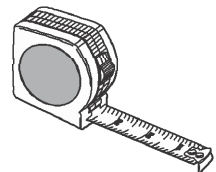
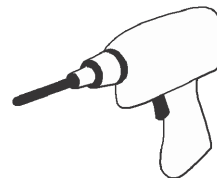
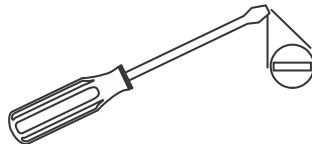
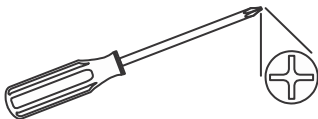

ASSEMBLY INSTRUCTIONS

1. Turn the fireplace top panel over. Using the connector brackets that are supplied, connect the fireplace top panel to the triangular top triangle panel with ST4 screw - 5/8 in. (CC) as shown in Fig. 1.

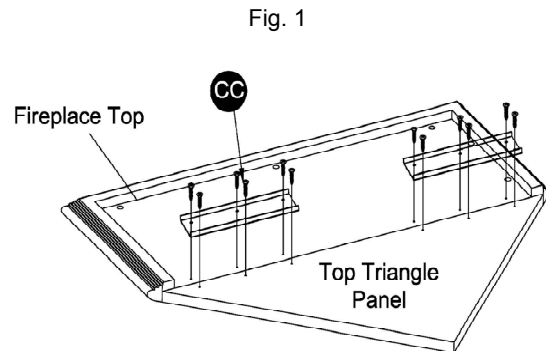

With the fireplace top panel assembled, reattach the assembled top with the fireplace.

Hardware Used

CC ST4 Screw - 5/8 in.  x12

2. Attach the left and right rear barrier trim pieces to the back of the fireplace with ST4 screw - 1 3/16 in. (BB) as shown in

Fig. 2.

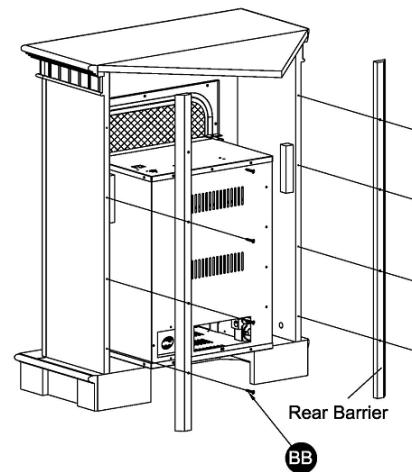

Hardware Used

BB ST4 Screw - 1 3/16 in.  x 8

3. Drill two holes ($\frac{5}{16}$ in.) in the corner where the fireplace is to be displayed. Drill the first hole $34 \frac{5}{16}$ in. from the ground up; and the second hole 36 in. from the ground up as shown in Fig. 3. Put the wall anchors (DD) in the holes by pinching the anchor tabs together.

Fig. 3

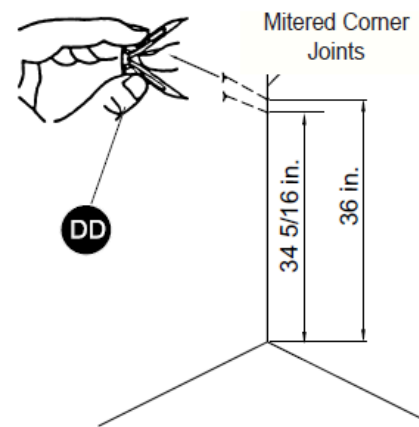

Hardware Used



4. Attach the triangular wood block to the holes drilled in step 4 with ST5 screw - $2 \frac{3}{8}$ in. (AA) as shown in Fig. 4. This block is used to support the top triangle panel.

Fig. 4

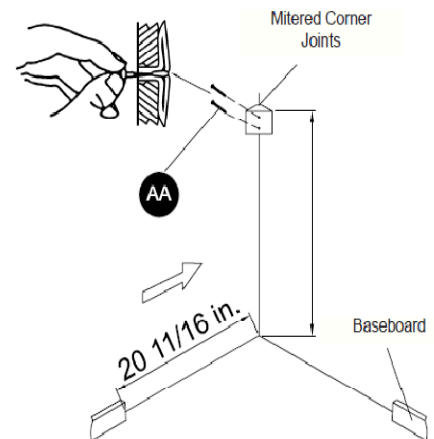

Push fireplace into corner so that the top triangle panel is resting on top of the wood block.

Hardware Used

