

*PORTABLE  
KEROSENE-HEATER  
"OWNER'S MANUAL"*

**DuraHeat<sup>®</sup>**

**MODEL:  
DH - 1010**



LISTED

Before the first use of this heater, please read this OWNER'S MANUAL very carefully. This OWNER'S MANUAL has been designed to instruct you as to the proper manner in which to assemble the heater, maintain the heater, store the heater, and most importantly, how to operate the heater in a safe and efficient manner, please keep this manual for future reference.

**WORLD MARKETING OF AMERICA, INC.  
RT. 22 WEST, P.O. BOX 192  
MILL CREEK, PA 17060  
1-800-776-9425 (9 AM - 4 PM EST)  
MON.-FRI. ONLY  
[www.yourheater.com](http://www.yourheater.com)**

# CAUTIONS

## - SAFETY GUIDE -

### **1 WARNING!! RISK OF EXPLOSION / RISK OF FIRE**

- ! NEVER use any fuel other than water-clear 1-K kerosene.
- ! NEVER use fuel such as gasoline, benzene, paint thinners or other oil compounds in this heater.
- ! NEVER refill heater fuel tank when heater is operating or still hot.
- ! NEVER use heater in areas where flammable vapors or gases may be present.
- ! NEVER fill heater fuel tank in living space; fill tank outdoors.
- ! NEVER store or transport kerosene in other than a metal or plastic container that is (1) acceptable for kerosene, (2) non-red in color, and (3) clearly marked "Kerosene." NEVER store kerosene in the living space; kerosene should be stored in a well ventilated place outside the living area.
- ! The unit is **EXTREMELY HOT** while in operation. Due to high surface temperatures, keep children, clothing, furniture, and other combustible objects at least 36" away from top and front area.
- ! NEVER use gasoline in this heater. (RISK OF FIRE)
- ! **RISK OF INDOOR AIR POLLUTION**  
**USE HEATER ONLY IN WELL VENTILATED AREAS.** People with breathing problems should consult a physician before using the heater. In a house of typical construction, that is, one that is not of unusually tight construction due to heavy insulation and tight seals against air infiltration, an adequate supply of air for combustion and ventilation is provided through infiltration; however, if the heater is used in a small room where less than 200 cubic feet (5.7 m<sup>3</sup>) of air space is provided for each 1,000 BTU per hour of heater rating (considering the maximum burner adjustment), the door(s) to adjacent room(s) should be kept open or the window to the outside should be opened at least 1 inch (25.4 mm) to guard against potential buildup of indoor air pollution. DO NOT use the heater in a bathroom or any other small room with the door closed.
- ! NEVER use heater to heat or boil water or use as a cooking appliance.
- ! NEVER use gasoline in this heater. (RISK OF FIRE)
- ! NEVER remove the cartridge tank when the heater is operating or when the heater is hot. NEVER use the cartridge tank to transport or store kerosene or any other flammable liquids.

Occasionally during normal operation you will hear

the sound of fuel draining from the cartridge tank to fill the fuel reservoir area. This is normal for a cartridge tank kerosene heater.

### **2 WARNING!! FAILURE TO INSTALL, MAINTAIN, AND/OR OPERATE THIS KEROSENE HEATER ACCORDING TO MANUFACTURER'S INSTRUCTIONS MAY RESULT IN CONDITIONS WHICH CAN PRODUCE BODILY INJURY AND/OR PROPERTY DAMAGE.**

**NOTE:** The **WARNING** and **IMPORTANT** instructions appearing in this manual are not meant to cover all possible conditions and situations that may occur. It must be understood that common sense, caution, and carefulness are factors which cannot be built into this heater. These factors must be supplied by the person(s) installing, maintaining, or operating the kerosene heater.

Always contact your dealer, distributor, service agent, or the manufacturer on any problems or conditions you do not understand.

- ! NEVER leave heater operating if you intend to leave for any period of time. Always make sure to turn heater off and inspect to insure that it is completely extinguished prior to going to bed.
- ! NEVER leave heater unattended.
- ! NEVER use as a source of heat for drying objects.
- ! NEVER place objects on the top plate.

### **3 WARNING!! RISK OF BURNS**

- ! NEVER operate the heater without the guard or grille completely attached.

**4 IF POOR QUALITY KEROSENE** is used a rapid accumulation of carbon and tar is likely. This may cause a strong odor and will destroy the wick. Additional heater damage may occur as the wick becomes more difficult to adjust. The use of poor quality fuel could also make the wick very hard to extinguish. Always make sure the fire is out. (See page 7, Extinguishing the Heater.)

**5 ADJUSTMENT OF ROOM TEMPERATURE** can not be changed by adjusting the heater. A kerosene heater is either on or off. There is no temperature adjustment. If heater output is reduced by lowering the wick in any way, improper combustion will occur producing odors and an accumulation of tar and carbon. If your room becomes too hot, open a door or a window or turn off the heater.

## SAVE THESE INSTRUCTIONS FOR FUTURE REFERENCE!!

## CONTENTS OF OWNER'S MANUAL

<u>ITEM</u>	<u>PAGE</u>	<u>ITEM</u>	<u>PAGE</u>
CAUTIONS-SAFETY GUIDE	1	11 WICK REPLACEMENT	10-12
1 INTRODUCTION	2	12 CHECKING THE IGNITION SYSTEM	13
2 FEATURES	2	13 WICK ADJUSTER MECHANISM	13
3 KEROSENE (1-K ONLY)	3	14 AUTOMATIC SAFETY SHUT-OFF DEVICE	13
4 UNPACKING AND ASSEMBLING THE HEATER	4	15 LONG TERM STORAGE OF YOUR HEATER	14
5 FUELING YOUR HEATER	5	16 SPECIAL SAFETY PRECAUTIONS	15
6 AUTOMATIC IGNITION SYSTEM	6	17 TROUBLE SHOOTING GUIDE	16
7 ADJUSTING THE WICK	7	18 PARTS LIST	17
8 EXTINGUISHING THE HEATER	7	19 EXPLODED PARTS DRAWING	17
9 WICK MAINTENANCE	9	20 SPECIFICATIONS	17
10 CARBON REMOVAL / DRY BURNING	9		

### 1 INTRODUCTION

Please read this OWNER'S MANUAL carefully. It will show you how to assemble, maintain, and operate the heater safely and efficiently to obtain full benefit from its many built-in features.

### 2 FEATURES

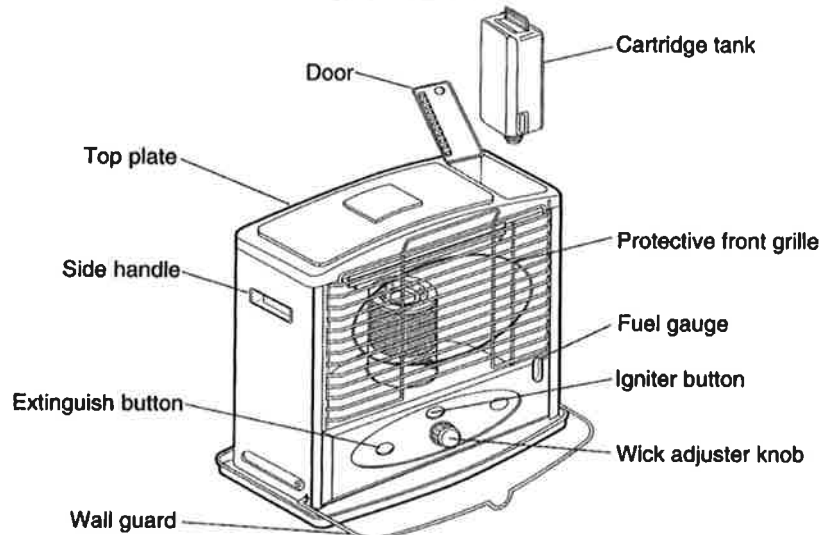

Fig. 1

### **☞ KEROSENE (1- K Only)**

It is **EXTREMELY IMPORTANT** to the operation of this heater that you use the proper grade of kerosene. The proper grade of kerosene is identified as **1-K Kerosene**. **DO NOT OPERATE THIS HEATER WITH ANY FUEL OTHER THAN 1-K KEROSENE!** 1-K Kerosene has been refined to virtually eliminate contaminants such as sulphur, which can cause a rotten egg odor during operation of the heater.

**KEROSENE SHOULD ONLY BE STORED IN A BLUE CONTAINER THAT IS CLEARLY MARKED "KEROSENE". NEVER STORE KEROSENE IN A RED CONTAINER.** Red containers are associated with gasoline.

**NEVER** store kerosene in the living space. Kerosene should be stored in a well ventilated place outside the living area.

**NEVER** use any fuel other than water-clear 1-K kerosene.

**NEVER** use fuel such as gasoline, benzene, alcohol, white gas, camp stove fuel, paint thinners, or other oil compounds in this heater. These are volatile fuels that can cause explosion or uncontrolled flames.

The best way to purchase kerosene is in a pre-packaged, metal or plastic, blue colored container.

The second choice would be to buy it from a dealer who stores it in a 55 gallon drum. The third choice is to buy kerosene from a dealer who stores it in a large underground (or above ground) tank. Kerosene that is contaminated with even a small amount of water will prevent a kerosene heater from functioning properly. As you move from the first choice in purchasing kerosene (pre-packaged container) to the third choice (large storage tank), the likelihood of water being present from condensation increases. If you purchase kerosene in bulk, know your dealer.

It is normal for a kerosene heater to give off a slight odor upon start-up and shut-down.

After 5-10 minutes of operation, the heater should have reached its normal operating temperature and any odor should be very slight.

**NEVER** store kerosene in direct sunlight or near a source of heat.

**NEVER** use kerosene that has been stored from one season to the next.

Kerosene deteriorates over time. **"OLD KEROSENE" WILL NOT BURN PROPERLY IN THIS HEATER.**

A variety of problems can result from using poor quality kerosene --- smoke, odor, low flame, difficult ignition, difficult shut-down, flame flickers and dies, excessive burning down of the wick, reduced wick life, wick adjuster sticking, excessive deposits on the wick, etc.. If you encounter any of the problems listed above, check your kerosene. If you discover that the kerosene is the problem, get a fresh supply of **WATER-CLEAR 1-K KEROSENE** before using your heater again.

## **4 UNPACKING AND ASSEMBLING THE HEATER**

### **1. REMOVE THE HEATER AND ALL PACKING MATERIALS FROM THE BOX (Fig. 2)**

**NOTE:** Save the shipping carton and packing materials for future storage.

2. Open the grille from the right hand side. Remove the protective packing materials from the burner.
3. Open the cartridge tank cover on top of heater and remove the styrofoam protecting the top of the cartridge tank and the cardboard protecting the bottom of the cartridge tank.

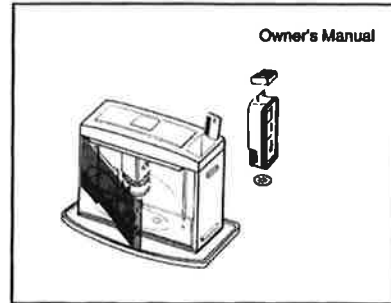

Fig. 2

### **4. Keep all packing materials in the carton box.**

5. Place the wall guard in the down position. **NEVER** operate the heater unless the wall guard is in the down position.

### **6. INSTALLING BATTERIES (Fig. 3)**

- The battery holder is located on the back of the heater.
- Insert two (2) "D" cell batteries (supplied with this heater) according to the plus (+) and minus (-) markings inside of the holder.
- Remove dead batteries at once and dispose of them properly. Remove batteries when not in use or when heater is being stored.

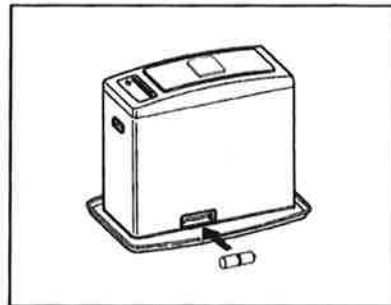

Fig. 3

### **7. POSITION THE BURNER (Fig. 4)**

- Position the burner on the wick adjuster.
- To confirm proper placement of the burner, grab the burner knob and rotate the burner back and forth three or four times until burner sets properly on the wick adjuster.

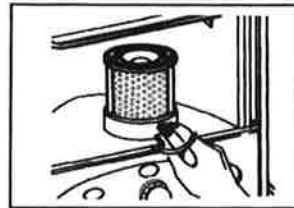

Fig. 4

### **8. TEST THE AUTOMATIC SAFETY SHUT-OFF DEVICE**

- Using the wick adjuster, turn the wick all the way up.
- Press the extinguish button. The wick should drop down to the lowest level.
- To test if the wick has dropped to the lowest level, try to turn the wick down further with the wick adjuster knob. If the wick cannot be turned down any further, the automatic safety shut-off device is functioning properly. Do not operate the heater if the automatic safety shut-off device is not functioning properly.

## **FUELING YOUR HEATER**

**NOTE :** See section 3, page 3 on **KEROSENE** for instructions on the proper grade of kerosene to use with this heater.

**CAUTION :** NEVER REMOVE THE CARTRIDGE TANK FROM THIS HEATER WHILE THE HEATER IS OPERATING OR WHILE THE HEATER IS STILL HOT. EXTINGUISH THE HEATER AND VERIFY THAT THE HEATER IS COOL TO THE TOUCH BEFORE REFUELING THE HEATER. NEVER REFILL THE CARTRIDGE FUEL TANK WHEN THE HEATER IS OPERATING OR STILL HOT.

**NEVER FILL THE HEATER'S CARTRIDGE FUEL TANK IN THE LIVING SPACE ;  
FILL THE CARTRIDGE FUEL TANK OUTDOORS.**

Before fueling the heater, take the removable cartridge fuel tank, the kerosene, and the manual siphon pump outdoors. To use the manual siphon pump, tighten the cap on the top of the siphon, place the straight tube into the kerosene container, and insert the flexible tube into the opening of the cartridge tank (see Fig. 5A/5B). By squeezing the bulb of the siphon pump, fuel will be transferred from the kerosene container into the heater. Carefully watch the fuel gauge on the cartridge tank so that you will know when the tank is getting full. When you approach the full mark, loosen the cap on top of the siphon pump. This will stop the flow of kerosene. **DO NOT OVERFILL THE CARTRIDGE TANK.** Allow the siphon pump to drain thoroughly before you remove it from the cartridge tank and the kerosene container.

Make sure that you securely replace the fuel tank cap on the cartridge tank and on the kerosene container. Thoroughly clean up any spilled kerosene.

Insert the cartridge tank back into the kerosene heater with the fuel gauge facing toward the front of the heater. (If the cartridge tank is not inserted properly into the heater, the door on the cartridge tank will not close.)

**NOTE :** Refill the cartridge fuel tank before the tank is completely empty (see Fig 6 ). DO not refill when the heater is operating or still hot.

### **IMPORTANT NOTICE REGARDING FIRST FUELING OF HEATER ;**

When first using your heater, make sure that you allow a **minimum of 30 minutes** (carefully check the time) after filling the tank before you attempt to light the heater. This allows time for the wick to become saturated.

### **IMPORTANT NOTICE REGARDING FIRST IGNITION OF HEATER ;**

The first time you light the heater, it should be done **outdoors**. This allows the oils, etc. used in manufacturing the heater to burn off outside, rather than in your home.

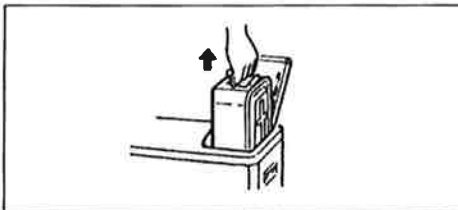

Fig. 5A

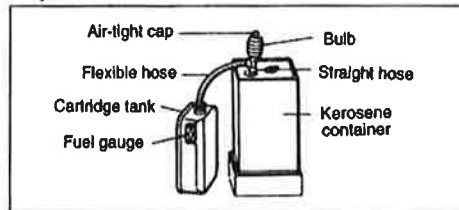
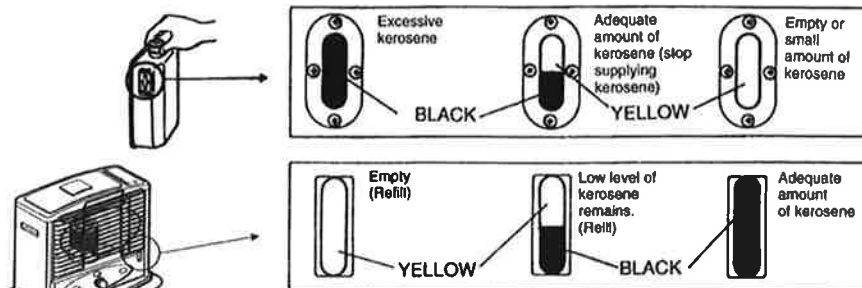

Fig. 5B

**NOTE :** Extinguish the kerosene heater and refill the tank before the fuel reaches the bottom of the cartridge tank. (Fig 6.)



## **⑥ AUTOMATIC IGNITION SYSTEM**

For safety and convenience, this heater features an automatic ignition system. 2 "D" cell batteries, included with the heater, provide the power for the igniter which lights the wick once it has been raised to its maximum height.

When the heater is fueled for the first time, allow a **minimum of 30 minutes** after filling the heater before you attempt to light the heater. Also, the first time you light the heater, it should be done **outdoors** to allow the oils, etc. used in manufacturing the heater to burn off outside, rather than in your home.

### **To use the automatic ignition system :**

- Make sure the batteries have been installed.
- Turn the wick adjuster knob clockwise until the wick has been raised to its maximum height.
- Push the ignition button to bring the glowing igniter into contact with the wick. This will cause ignition to occur.
- As soon as you see that the wick has been lit, release the ignition button. This will automatically lower the burn chamber back down over the wick.
- Rotate the burner knob from side to side a few times to make sure that the burner is positioned properly on the wick adjuster.
- Then begin following the steps outlined in "Adjusting the wick" (page. 7)

## **IGNITION VIA MATCH**

If you encounter a problem with the ignition mechanism, or if you have dead batteries, it is possible to light the heater with a match (Fig. 7).

### **The procedure is as follows:**

- Turn the wick adjuster knob clockwise until the wick has been raised to its maximum height.
- Lift the burn chamber by using the burner knob.
- Touch a lighted match to the exposed top edge of the wick.
- Once you see that the wick has been lit, lower the burn chamber back down over the wick.
- Rotate the burner knob from side to side a few times to make sure that the burner is positioned properly on the wick adjuster.
- Then begin following the steps outlined in "Adjusting the wick" (page. 7)

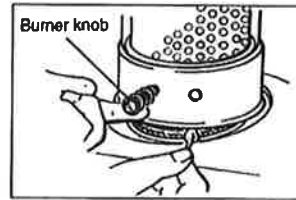

Fig. 7

**CAUTION :** Make sure that you do not leave the match, or any portion of it (match head, etc.) in the burner area. Debris left from the match can cause an uneven alignment of the burner and may result in smoke, incomplete combustion, odor, or fire.

**NOTE :** Once you have extinguished the heater, wait at least 10 minutes before reigniting the wick. Failure to do this will result in a very strong odor and/or smoke being produced.

**NOTE :** Do not use excessive force when pushing the ignition button. This can cause the igniter to catch the wick and may prevent ignition from occurring. Pushing too lightly on the Ignition button can prevent ignition from occurring by keeping the igniter too far from the wick. As Fig. 10 shows, the optimal distance between the igniter and the wick is 1/64--1/32 inch (0.5 to 1mm). If it is difficult to ignite the heater, the filament on the igniter might be bent, broken or misshaped.

## **7 ADJUSTING THE WICK**

After lighting the heater, it is important to check the heater flame within the first 5-7 minutes of operation. After 5-7 minutes of operation, you should use the wick adjuster knob to obtain the proper flame height (see Fig. 8). **IF THE FLAME IS TOO YELLOW, TURN THE WICK ADJUSTER KNOB DOWN SLIGHTLY UNTIL YOU GET THE BLUE FLAME INDICATED IN FIG. 8. IF THERE IS NO FLAME, OR A VERY LOW FLAME, TURN THE WICK ADJUSTER KNOB UP SLIGHTLY UNTIL YOU GET THE BLUE FLAME INDICATED IN FIG. 8.**

**VERY FINE ADJUSTMENTS TO THE FLAME CAN BE MADE BY GRABBING THE BURNER KNOB AND MOVING THE BURNER FROM SIDE TO SIDE UNTIL THE BLUE FLAME IS EVENLY DISTRIBUTED.**

**CAUTION :** Do not grab the burner knob once the heater has reached normal operating temperature and the flame has stabilized. The burner knob is very hot during operation.

As you continue to operate the heater, the temperature of the heater and the temperature of the room will continue to change. As the heater warms up, the kerosene in the tank will vaporize faster, and this could require adjusting the wick down in order to maintain the proper flame. **THE FLAME MAY NEED TO BE ADJUSTED DURING THE TIME THE HEATER IS BEING OPERATED.** Therefore, it is necessary to continue to monitor the flame, and to make adjustments using the wick adjuster knob to keep the proper flame height. It is recommended that the heater be checked every 30 minutes in order to keep the proper adjustment because periodic adjustment is required. **FAILURE TO KEEP THE WICK ADJUSTED PROPERLY WILL RESULT IN SMOKE, ODOR, IMPROPER COMBUSTION, CARBON BUILD-UP, AND A SHORTER WICK LIFE.**

**NOTE :** Occasionally during normal operation you will hear the sound of fuel draining from the cartridge tank to fill the fuel reservoir area. This is normal for a cartridge tank kerosene heater.

**WARNING :** NEVER turn the wick adjuster knob lower than the "LOW" setting of the wick adjustment. If you operate the heater below the position where the wick stop engages (the "LOW" setting), smoke, odor, excess emissions, CO (carbon monoxide), and flare-ups can result.

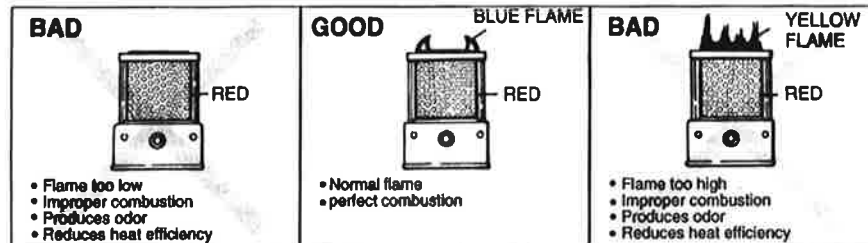

Fig. 8

## **8 EXTINGUISHING THE HEATER**

To extinguish the heater, push the extinguish button. This should lower the wick to its lowest level. If the wick is not completely lowered, continue to push the extinguish button and turn the wick adjuster knob in a counterclockwise direction (towards "OFF") as far as it will go. After 2 or 3 minutes, lift up the burner assembly using the burner knob and confirm that the heater has extinguished. (see Fig. 9.)



**NOTE :** Carbon build-up on the wick may prevent the wick from completely lowering when the extinguish button is pushed. This can result in the flame not extinguishing. If this happens, continue to push the extinguish button and turn the wick adjuster knob in a counterclockwise direction (towards "OFF") as far as it will go. If this condition exists, inspect the heater and perform the checks and maintenances described on page 9.

**NOTE :** If the heater is jarred or shaken, the automatic safety shut-off device may automatically function.

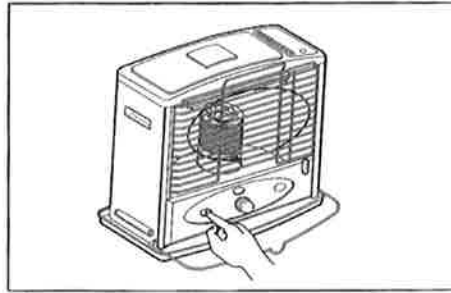

(Fig. 9)

**CAUTION :** NEVER adjust or attempt to disassemble the automatic safety shut-off extinguishing device. This can cause the automatic safety shut-off extinguishing device to not function properly in the case of an emergency.

**CAUTION :** After extinguishing the heater, allow at least 10 minutes before reigniting the heater. This allows the heater time to cool off and return to a normal temperature. Failure to allow the 10 minute cooling off period before reigniting the heater will result in the creation of a strong odor and possible flare-up.

**WARNING :** Carbon and tar can build up on the wick after the heater has been in use for a while. This can interfere with the ability of the wick to be lowered into the body of the heater, and can result in the flame not extinguishing completely. It is the responsibility of the owner to inspect the wick, to maintain proper maintenance of the wick, and to replace the wick when necessary in order to prevent the build up of carbon and tar from creating a dangerous situation where the heater does not fully extinguish.

## DAILY CHECK AND MAINTENANCE PROCEDURE

It is important to perform the following check and maintenance procedure on a daily basis during the heating season.

**WARNING :** In performing the check and maintenance procedure,

**NEVER ATTEMPT TO REPAIR THE FOLLOWING PARTS :**

- Automatic safety shut-off Device - Do not adjust or attempt to disassemble this important safety device.  
Do not spill kerosene on the device. This is the principal safety mechanism of the heater.
- Fuel Gauge - Do not remove or unfasten the screws that attach the fuel gauge to the tank.  
Do not disassemble the fuel gauge.

• **Inspect the cleanliness of the heater**

Keep the heater clean at all times. Keep the reflective panel free from dust, dirt, oil, grease, etc.. It is not safe to use a dirty kerosene heater. Dirt, dust and spilled kerosene cause unwanted odors.

• **Inspect the cartridge tank**

Lift out the cartridge tank and inspect for dents, cracks, leaks, etc.. If present, replace the tank at once. Check the drip tray to see if kerosene is present. This could indicate a leak. Do not use the heater if kerosene is present in the drip tray. Check for rust or foreign materials in the tank or fuel reservoir.

• **Inspect wick adjuster and wick guide cylinder**

Check daily to look for carbon accumulation. If carbon is present, lower the wick and remove the carbon using a flat edge screwdriver. Be careful not to allow any carbon deposits to drop into the heater.

• **Inspect the igniter**

If the automatic ignition system does not work, check the filament on the igniter (see Fig. 10) to see if it is broken or misshapen. A small distortion can be fixed with a match stick. If the filament is stretched or broken, replace the igniter with a new one. **NOTE :** Remove the batteries before replacing the igniter. Refer to section "CHECKING THE IGNITION SYSTEM" on page 13 for instructions on how to replace the igniter.

• **Inspect the batteries**

If the igniter filament does not get hot enough to ignite the wick and the igniter filament appears to be normal, replace the batteries.

• **Inspect the wick**

Inspect the wick before each use to see if carbon has accumulated on the wick. If it has, perform the Carbon Removal procedure described on page 9.

Check the height of the wick as described on page 7.

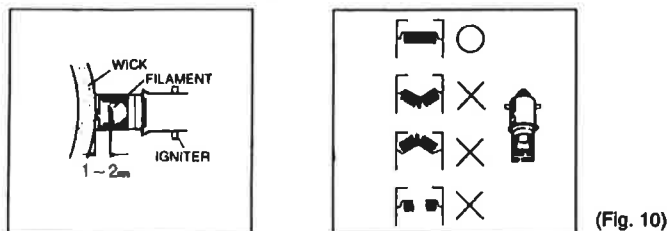

(Fig. 10)

### **9 WICK MAINTENANCE**

Carbon and tar will build up on the top of wick after the heater has been in use for a while. It is very important that the carbon and tar build up be removed in order for the heater to burn properly, and in order for the heater to properly extinguish. After every 2-3 tankfuls of fuel, check the top of the wick. If it feels hard and brittle, there is a build up of carbon on the wick. You might even observe a coating of black carbon on the top of the wick. A wick that is in good condition will feel soft.

There are other checks you can perform to determine if there is a build up of carbon on the wick. If it is difficult to turn the wick adjuster knob, if it is hard to ignite the heater, if it is difficult to obtain the proper wick height, these are signs that there may be a build up of carbon on the top of the wick. To eliminate the carbon build up from the top of the wick, perform the "Carbon Removal / Dry Burning" procedure outlined in the next section.

### **10 CARBON REMOVAL / DRY BURNING**

The "Carbon Removal / Dry Burning" procedure creates a strong odor. Therefore, this procedure should always be performed outdoors on a windless day. You can consider using a porch or other well ventilated area, but keep in mind the fact that a strong odor is produced.

**Carbon Removal Procedure :**

- As the fuel level in the heater approaches empty, continue to burn the heater without refilling. Once the tank becomes empty and the flame starts to burn out, raise the wick to its maximum height and leave it burning until it burns out completely. After it has burned out, wait 30 minutes, reignite the wick (use a match, if necessary), and allow it to burn out again. Once it has cooled off, use a small brush or an old toothbrush to remove any ash that remains.

- This procedure should remove the carbon from the top of the wick. The wick should feel softer. If some parts of the wick still feel stiff, pinch these sections with a pair of small pliers. This will break up any remaining carbon into small pieces. Once you have done this, add a small amount of kerosene to the tank and repeat the "Carbon Removal" process again. After completing the "Carbon Removal" procedure, refill the tank and wait at least 30 minutes before reigniting the heater.

You should perform the "Carbon Removal" procedure within 7 days of your first use of the heater. After that, the "Carbon Removal" procedure should be performed whenever the build up of carbon causes the wick to become stiff. "CARBON REMOVAL" SHOULD BE DONE EVERY WEEK DURING THE HEATING SEASON. IT MAY BE NECESSARY TO DO IT MORE OFTEN DEPENDING UPON THE CARBON BUILD UP ON THE WICK. CHECK THE WICK FREQUENTLY TO DETERMINE WHEN TO DO THE "CARBON REMOVAL" PROCEDURE.

## **ii WICK REPLACEMENT**

Wick replacement should be performed on a completely cool heater after the cartridge tank has been removed and the remainder of the kerosene in the heater has been burned off.

Use only genuine replacement wick.

Replacement wick number : Glowick 200-B, Kero-World 20401-U, Dura Heat DH-200, Pick-A-Wick-PW27.

Open the tank cover and remove the cartridge tank. Remove the batteries to prevent possible burns. Open the front grille and remove the chimney. Remove the wick adjusting knob by pulling straight out.

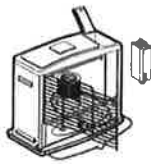

Step 1

Unscrew 3 screws, one from the back and one from each side of the cabinet.



Step 2

Remove the cabinet.

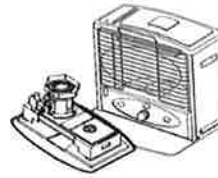

Step 3

Unscrew the screw on the wind cover.



Step 4

Remove the wind cover.

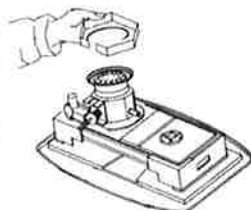

Step 5

Remove the automatic ignition Assembly by unscrewing 2 screws.



Step 6

Unscrew 4 wing nuts.

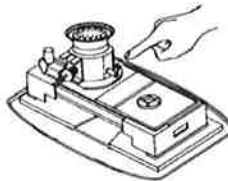

Step 7

Remove the wick adjuster assembly.



Step 8

Remove the wick from the holder by folding it. Loosening it from the sharp metal teeth on the inner surface of the holder, and sliding it out.



Step 9

## **I) WICK REPLACEMENT**

Wick replacement should be performed on a completely cool heater after the cartridge tank has been removed and the remainder of the kerosene in the heater has been burned off.

Use only genuine replacement wick.

Replacement wick number : Glowick 200-B, Kero-World 20401-U, Dura Heat DH-200, Pick-A-Wick-PW27.

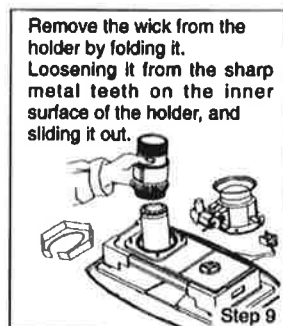
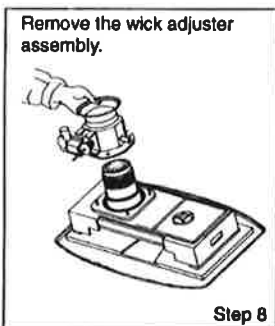
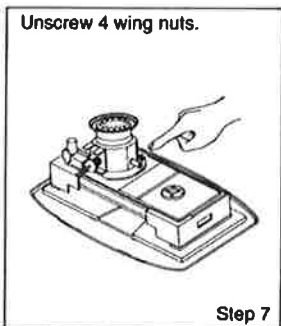
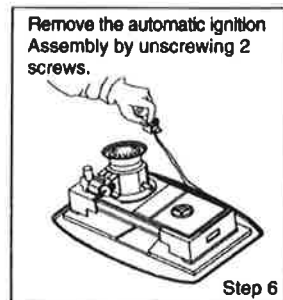
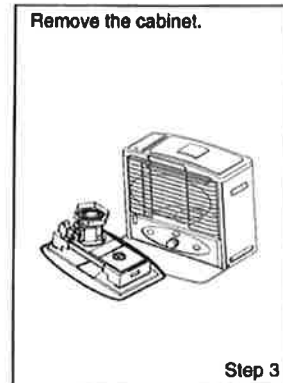
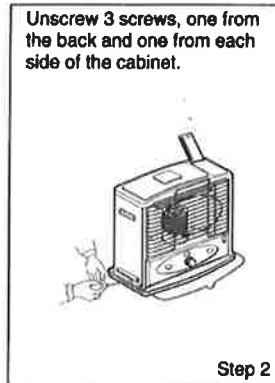
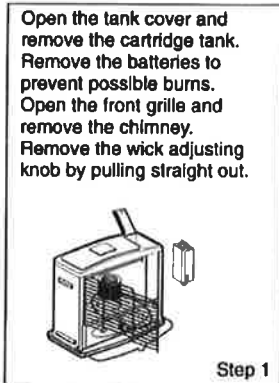

Replacement wick has a black line. Fold the new wick and slide it into the holder.



Step 10

The black line on the outside of the wick should match the top edge of the holder. Then press it against the teeth inside the holder to obtain a firm grip.



Step 11

Replace the wick and holder in the burner tank. Rotate 90 degree left and right as well as up and down until the wick slides freely. Check to see that gasket is still in place on the burner tank.

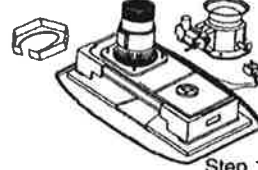

Step 12

It is recommended to reinstall the wick adjusting knob for easier assembling.



Step 13

Align ratchet pin "A" so it is positioned in the middle of the cut-out, but does not touch either side.



Step 14

Turn knob slightly clockwise so that shaft engages wick holder at highest point. In this case the flat side of the shaft will be tilted slightly to the right.

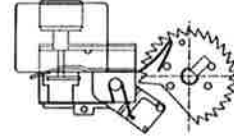

Step 15

Insert the pinion at the other end of the wick control shaft into top portion of the rack of the wick holder. This step can be easily carried out if the wick holder is raised.



Step 16

Slide the wick abjuser assembly down the draft tube. Position the adjuster shaft to the front of the heater. The flat side of the shaft should now be in upright position.

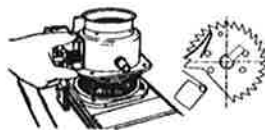

Step 17

Turn the knob clockwise and counter-clockwise a few times to make sure the wick travels up and down smoothly.

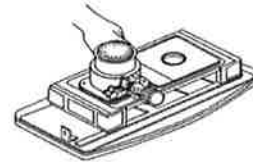

Step 18

Snug 4 wing nuts on the mounting stud, but do not tighten.

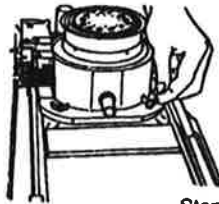

Step 19

Raise the wick to the full "up" position, and evenly tighten wing nuts in several steps.



Step 20

Check wick height  $8 \pm 1$  mm.

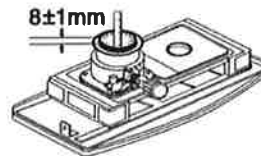

Step 21

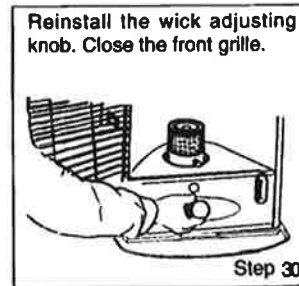
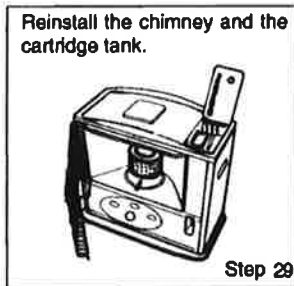
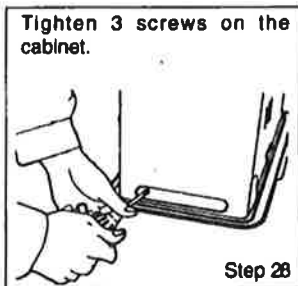
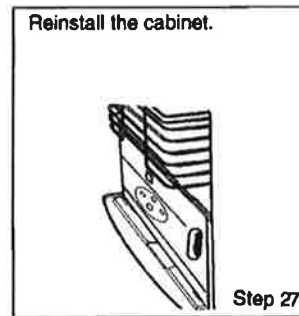
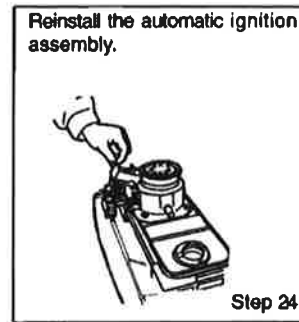
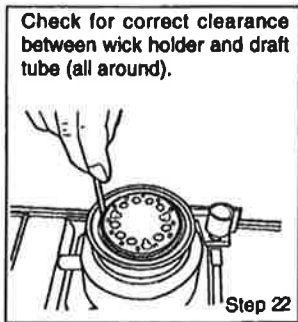

Install the battery case, Fill the Cartridge tank with clean, pure kerosene. Set the tank into the heater and wait at least 30 minutes for the new wick to fully saturate with kerosene.

## **12 CHECKING THE IGNITION SYSTEM**

If the automatic ignition system fails to operate properly, perform the following checks:

- **BATTERIES** - 2 "D" cell batteries are located at the rear of the heater. Replace with new batteries.
- **IGNITER PLUG** - If the automatic ignition system still doesn't work after replacing the batteries, check the igniter plug. If the glow coil filament is broken, bent, or doesn't glow when engaged via the ignition lever, it must be replaced. **CAUTION: Be sure igniter plug is 2.5V DC, 1A only.**

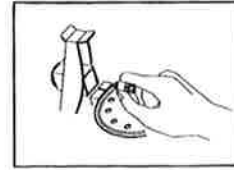

Fig. 11

To replace the igniter plug (Fig. 11) ;

- Remove the batteries.
- Open the protective grille and remove the burner assembly.
- Push the ignition button to raise the igniter plug.
- Push the igniter plug in and turn in a **counterclockwise** direction to remove.
- Install a new igniter plug (2.5V DC, 1A only) by pushing it in and turning it in a **clockwise** direction.
- Replace the burner assembly, close the protective grill, and reinstall the batteries.

## **13 GLASS CYLINDER REPLACEMENT**

Remove speed nuts holding cross pins. Then pull out cross pins. Replace glass cylinder. In reassembling, make sure that inner and outer cylinders are set in their proper places.

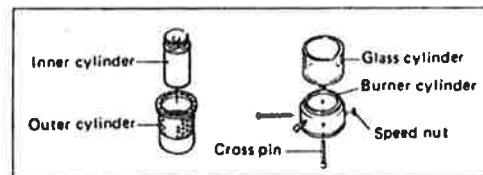

## **13 WICK ADJUSTER MECHANISM**

Turning the wick adjuster knob in a clockwise direction lifts the wick to the top of the wick holder assembly. As the wick is dialed up, the torsion spring located on the wick control shaft is compressed. Raising the wick to the full up position allows the wick to come into contact with the igniter when the ignition knob is depressed. Pressing the extinguish button causes the torsion spring to rapidly lower the wick. You can slow the speed at which the wick is lowered by holding the wick adjuster knob when pressing the manual extinguish button. By slowly releasing the wick adjuster knob, you can slow the speed at which the wick is lowered and reduce the chance of encountering a kerosene odor when extinguishing the heater.

## **14 AUTOMATIC SAFETY SHUT-OFF DEVICE**

This heater is equipped with an automatic safety shut-off device. The purpose of this device is to quickly and efficiently shut off the heater should the heater be jammed or tipped over while in operation. This is the main safety system that is built into the heater, and it functions to prevent the flame from spreading if the heater is knocked over.

The automatic safety shut-off device is built into the mechanism that raises and lowers the wick. It has been designed so that if the pendulum is jarred by a shock of some sort, it retracts a latch from the wick control shaft ratchet, and a torsion spring reacts to drop the wick to its fully lowered position. This rapid lowering of the wick extinguishes the flame.

**IMPORTANT NOTICE :** For the automatic safety shut-off device to function properly, the wick must be free of carbon and tar deposits. Regularly performing the "Carbon Removal / Dry burning" procedure described in the "Wick Maintenance" and "Carbon Removal / Dry Burning" sections on page 9 is very important to the proper functioning of this important safety device.

**IMPORTANT NOTICE :** PLEASE CHECK THE AUTOMATIC SAFETY SHUT-OFF DEVICE ONCE A WEEK DURING THE HEATING SEASON TO INSURE THAT IT IS FUNCTIONING PROPERLY.

**IMPORTANT NOTICE:** EVERY TIME THE WICK IS REMOVED OR REPLACED, THE AUTOMATIC SAFETY SHUT-OFF DEVICE MUST BE TESTED TO INSURE THAT IT IS FUNCTIONING PROPERLY.

**TESTING THE AUTOMATIC SAFETY SHUT-OFF DEVICE :** At least once a week during the heating season, it is important to test the safety shut-off device to be sure that it is operating properly. **WITH THE HEATER TURNED OFF**, raise the wick using the wick adjuster knob to the fully raised position. Grabbing the protective grille, give the heater a firm shake. If the automatic safety shut-off device is working properly, you will hear a loud noise as the ratchet is disengaged and the torsion spring drops the wick into the body of the heater. To verify that the wick has been completely lowered, turn the wick adjuster knob in a counterclockwise direction. If the automatic safety shut-off device is functioning properly, the wick will have been completely lowered. If you are able to lower the wick further using the wick adjuster knob, this means that it is time to perform the "Carbon Removal Dry Burning" procedure described on page 9 again.

## **15 LONG TERM STORAGE OF YOUR HEATER**

Carefully following the instructions for storage given below will insure that your heater will operate efficiently and safely next season (Fig. 12 / Fig. 13).

- Using a small amount of kerosene, swirl and rinse the inside of the tank. **NEVER** mix water with the kerosene as it will cause rust inside the tank. Pour the kerosene out making sure that you remove it all.
- With the fuel tank empty, ignite the heater. With the wick at its maximum height, keep the wick burning until it burns out completely (about 1 hour). It is a good idea to do this outside or in an extremely well ventilated area.
- Remove the batteries and the burner assembly. Then, remove the wick adjuster from the fuel reservoir. Dry the inside of the fuel reservoir completely. If carbon has accumulated on the wick adjuster, remove it. Remove any carbon or soot that is present on the burner assembly.
- Remove the batteries. Remove the 2 cabinet screws and lift off the the cabinet and grille assembly. Remove the burner. Remove the wick adjuster from the fuel reservoir. Thoroughly dry the inside of the fuel tank. Using a screwdriver and/or a brush, remove any carbon, tar or soot that might have accumulated on the wick adjuster, wick guide or burner.
- After a through cleaning, reassemble the heater. It is important when reassembling the wick adjuster to be sure to maintain an equal gap between the wick adjuster and the wick guide cylinder all around. See "Wick Replacement" on page10 for reference.
- Remove the batteries from the battery case before storing the heater to prevent leakage and corrosion.
- Store the heater with the wick in the fully lowered position and the automatic safety shut-off device deactivated.
- Store the heater in the original box with the original packing material and keep the **OWNER'S MANUAL** with the heater. Store in an area that is well ventilated.

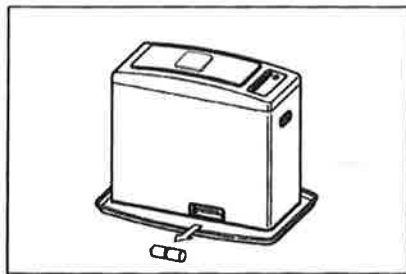

Fig. 12

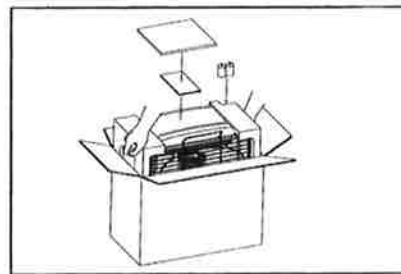

Fig. 13



## **■ SPECIAL SAFETY PRECAUTIONS**

### **Where to use your kerosene heater**

- Only use a kerosene heater in a level position.
- Do not place a kerosene heater in a traffic areas such as an entrance or exit. Do not use a kerosene heater in a windy area.
- Do not place a kerosene heater under a mantelpiece or a high raised area.
- Do not use a kerosene heater in a room where the temperature is more than 86° F (30 °C).
- Do not use a kerosene heater near curtains or near any other flammable objects.
- Do not use a kerosene heater in a moving vehicle or in any other unstable environment.
- Never leave the heater unattended while burning.

### **How to use your kerosene heater**

- **Do not try to operate your kerosene heater until you have completely read this owner's manual.**
- After igniting the wick according to the instructions in this owner's manual, confirm that the wick is burning in a normal manner. Having the wick raised too high, or lifting the burner can cause abnormal burning. This can be dangerous. The flame may need to be adjusted during the time the heater is being operated (see "Adjusting the Wick", section 7, page 7). Failure to keep the wick adjusted properly will result in smoke, odor, improper combustion, carbon build-up, and a shorter wick life.
- **Use heater only in well ventilated areas.** If there is a shortage of oxygen in the room where the heater is being used, this can cause improper combustion and can generate carbon monoxide.
- **Never** use heater in areas where flammable vapors or gases may be present.
- **Never** use the heater as a source of heat for drying objects.
- **Never** attempt to carry the heater while it is operating.
- **Never** use the heater to heat or boil nor use as a cooking appliance.
- **Never** touch any part of the top plate or front grille while the heater is operating. These surfaces are hot.
- **Never leave the heater unattended while burning.** Always make sure to turn the heater off and inspect to insure that it is completely extinguished prior to going to bed.
- If the heater is burning abnormally, and you cannot extinguish it by using the extinguish button, use a fire extinguisher to extinguish the heater.
- **Never** use any fuel other than water-clear 1-K kerosene.
- **Never** expose the glass cylinder to water.

### **How to check and maintain your kerosene heater**

- Carefully follow the procedure outlined in the "Daily Check and Maintenance Procedure" in this owner's manual page 8.
- If there is any problem with this heater, have it fixed before operating the heater. Operating the heater when a problem exists (even a minor one ) can be dangerous.
- Carefully follow the procedure outlined in the "Wick Maintenance" section (section 9, page 9) and the "Carbon Removal / Dry Burning" section (section 10, page 9) in order to insure that the wick is in proper condition.

**17 TROUBLE SHOOTING GUIDE**

TROUBLES	CORRECTIVE ACTION
<p><b><u>Heater Will Not Light ;</u></b></p> <ol style="list-style-type: none"> <li>1. Fuel tank is empty</li> <li>2. Water present in kerosene</li> <li>3. Igniter plug Fails to Glow</li> <li>4. Igniter plug makes contact with side of wick</li> </ol>	<ol style="list-style-type: none"> <li>1. Fill tank with <b>water-clear 1-K kerosene</b>.</li> <li>2. Drain tank. Remove wick assembly &amp; replace wick. Reinstall wick assembly. Fill tank with <b>water-clear 1-K kerosene</b>.</li> <li>3. Replace batteries. Replace igniter plug. Check for broken or disconnected wire.</li> <li>4. Lower wick using wick adjuster knob until igniter plug makes contact with top of wick.</li> </ol>
<p><b><u>Heater Produces Smoke or Odor ;</u></b></p> <ol style="list-style-type: none"> <li>1. Flame is too high</li> <li>2. Heater is in an air draft</li> <li>3. Burner is not level</li> <li>4. Carbon or tar built up on wick</li> <li>5. Contaminated kerosene</li> </ol>	<ol style="list-style-type: none"> <li>1. Using wick adjuster knob, lower wick to desired 1/2" flame.</li> <li>2. Move heater out of air draft.</li> <li>3. Using burner knob, rotate burner from side to side until it seats properly over wick.</li> <li>4. Perform "Carbon Removal / Dry Burning" procedure. Replace wick if necessary.</li> <li>5. Drain tank. Remove wick assembly &amp; replace wick. Reinstall wick assembly. Fill tank with <b>water-clear 1-K kerosene</b>.</li> </ol>
<p><b><u>Flame Flickers or Dies ;</u></b></p> <ol style="list-style-type: none"> <li>1. Water present in kerosene</li> <li>2. Carbon or tar built up on wick</li> </ol>	<ol style="list-style-type: none"> <li>1. Drain tank. Remove wick assembly &amp; replace wick. Reinstall wick assembly. Fill tank with <b>water-clear 1-K kerosene</b>.</li> <li>2. Perform "Carbon Removal / Dry Burning" procedure. Replace wick if necessary.</li> </ol>
<p><b><u>Wick Burning Down Excessively ;</u></b></p> <ol style="list-style-type: none"> <li>1. Dangerous, volatile fuel mixed with kerosene (gasoline, benzene, alcohol, white gas, paint thinner, camp, stove fuel, oil compound)</li> </ol>	<ol style="list-style-type: none"> <li>1. Drain and clean tank               <ul style="list-style-type: none"> <li>— Remove and replace wick</li> <li>— Fill tank with <b>water-clear 1-K kerosene</b>.</li> </ul> </li> </ol>
<p><b><u>Wick Adjuster Sticks ;</u></b></p> <ol style="list-style-type: none"> <li>1. Water present in kerosene</li> <li>2. Carbon or tar built up</li> </ol>	<ol style="list-style-type: none"> <li>1. Drain tank. Remove wick assembly &amp; replace wick. Reinstall wick assembly. Fill tank with <b>water-clear 1-K kerosene</b>.</li> <li>2. Perform "Carbon Removal / Dry Burning" procedure. Replace wick if necessary.</li> </ol>
<p><b><u>Heater is enveloped in flames ;</u></b></p>	<ul style="list-style-type: none"> <li>— Call Fire Department.</li> <li>— Smother flames with fire extinguisher or sand. Otherwise smother flames with blankets and then throw water on blankets. Do not throw water directly on the heater itself.</li> </ul>

## PARTS LIST

DRAWING NUMBER	DESCRIPTION	PART NUMBER
1	FUEL CAP	08-4201
2	HINGE SPRING	Ref
3	DOOR	Ref
4	TOP PLATE	Ref
5	CARTRIDGE TANK	Ref
6	BAFFLE ASS'Y	
7	VERTICAL REFLECTOR	Ref
8	BOTTOM REFLECTOR	Ref
9	CABINET HANDLE	08-5602
10	CABINET	08-5010
11	FUEL INDICATOR WINDOW	Ref
12	TOP FRONT PANEL	Ref
13	FRONT PANEL	Ref
14	WICK HOLDER GASKET	08-4601
15	BATTERY CASE ASSY	08-2111
16	TANK HOLDER	Ref
17	BURNER TANK ASS'Y	08-4796
18	DRIP TRAY ASS'Y	08-5211
19	BURNER ASS'Y	08-0115
20	GRILLE	08-5411
21	WIND COVER	Ref
22	IGNITION COIL	DH 31
23	SAFETY SHUTOFF DEVICE	08-3015
24	IGNITER ASS'Y	08-2015
25	WICK ADJUSTER	08-1015
26	WICK ADJUSTER KNOB	08-1700
27	WICK HOLDER	08-1215
28	WICK	See Specs Below
29	WING NUT	08-9501
30	TOP DRAFT TUBE B	Ref
31	TOP DRAFT TUBE A	Ref
32	GLASS CYLINDER	08-0512
33	BOTTOM INSULATOR ASSY	Ref
34	TOP INSULATOR	Ref
35	WALL GUARD	Ref
36	CARTRIDGE TANK ASSY	08-4101

REPAIR OF DAMAGED OR LEAKING CARTRIDGE TANK ASSEMBLY MUST BE DONE BY A FACTORY AUTHORIZED SERVICE STATION.

## EXPLODED PARTS DRAWING

NOTE: SPECIFY MODEL NUMBER AND PART NUMBER WHEN ORDERING PARTS.

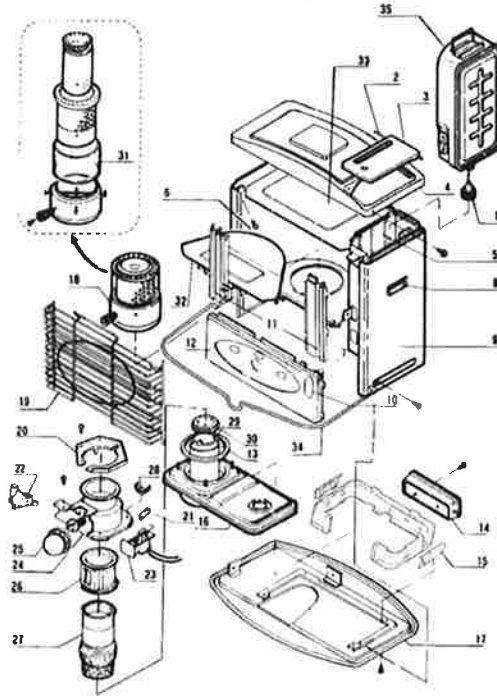

## SPECIFICATIONS

Model No.	DH-1010	
Type of Heater	Radiant Reflection	
Heat Output	Max. 10,000 BTU/hr	
Fuel Tank	Cartridge	
Tank Capacity	1.0 U.S. gallon	
Continuous Combustion Time	Approx. 11-14 hr.	
Max. Fuel Consumption	0.07 U.S. gallons/hr.	
Ignition Method	Battery-D Cell x 2	
Weight(empty)	Approx. 26 Lbs.	
Dimensions	Height	20 inches
	Width	23 inches
	Depth	12 inches
Max. Wick Height	5/16" (8mm)	
Replacement Wick Number	Pick-A-Wick-PW27, Kero-World 20401-U, Dura Heat DH-200	
U.L. Listed	Yes	